



2007 Graphic Communication

Standard Grade – General

Finalised Marking Instructions

© Scottish Qualifications Authority 2007

The information in this publication may be reproduced to support SQA qualifications only on a non-commercial basis. If it is to be used for any other purposes written permission must be obtained from the Assessment Materials Team, Dalkeith.

Where the publication includes materials from sources other than SQA (secondary copyright), this material should only be reproduced for the purposes of examination or assessment. If it needs to be reproduced for any other purpose it is the centre's responsibility to obtain the necessary copyright clearance. SQA's Assessment Materials Team at Dalkeith may be able to direct you to the secondary sources.

These Marking Instructions have been prepared by Examination Teams for use by SQA Appointed Markers when marking External Course Assessments. This publication must not be reproduced for commercial or trade purposes.

General

- 1** (a) Repetitive elements need not be redrawn/Saves effort/Productivity is increased KI 1
- (b) Digitiser Scanner Digital Camera Graphic Tablet KI 2
- (c) A Elevation/Orthographic KI 1
- (d) B Floor Plan C Location/Block Plan KI 2
- (e) Hard disk/Flash drive/Pen drive/Zip drive/External hard drive/CD-ROM/DVD-ROM/USB pen/Memory card KI 2
- (f) Symbol X North Point KI 1
- TOTAL KI 9**
- 2** (a) A Sawn Timber
B Insulation
C Brickwork
D Concrete KI 4
- (b) E Switch
F Socket Outlet
G Sink
H Wash Basin
J Bath
K Shower Tray KI 6
- TOTAL KI 10**
- 3** (a) Pictorial Views KI 1
- (b) A Planometric
B Isometric
C Oblique
D 2 Point Perspective KI 4
- (c) 1 Point Perspective KI 1
- (d) Angle X 30° KI 1
- (e) The size of the object to be drawn
The size of the paper being used
The amount of detail required KI 2
- (f) Drawn half size KI 1
- TOTAL KI 10**

4 (a)

Department	Task	Software Package Type
Administration Department	The production of letters to the firm's clients	Word Processing/DTP
Drawing Office	The production of new working drawings	CAD/ 3D Modelling
Sales and Marketing Department	The production of advertising leaflets containing text and graphics	DTP
Sales and Marketing Department	The production of promotional graphics showing light, shade and tone	Illustration/Paint/ 3D Modelling

KI 4

(b) Modem/Wireless Router

KI 1

(c) To make a copy of the data

KI 1

TOTAL KI 6

Question 5

- (a) Correct projection 1
 - (b) Rectangle (30 x 50) breadth and height (both needed) 1
 - (c) Rectangle and position (only one needed) 1
 - (d) Rectangle (5 x 20) and position (both needed) 1
 - (e) Pin shown (hidden detail) 1
- Total DA 5**

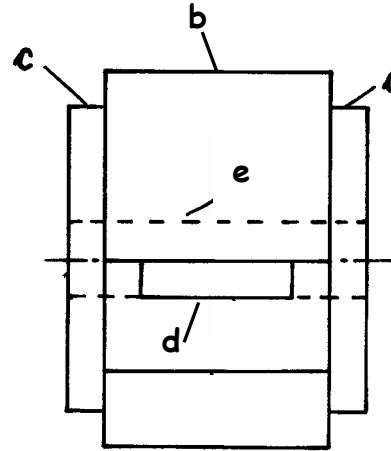
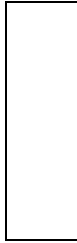

- (f) Width 30 1
 - (g) Width 5 (only one needed) 1
 - (h) Broken lines (two needed) 1
 - (i) Broken line 1
 - (j) Broken lines (two needed) 1
 - (k) Broken line 1
- Total DA 6**

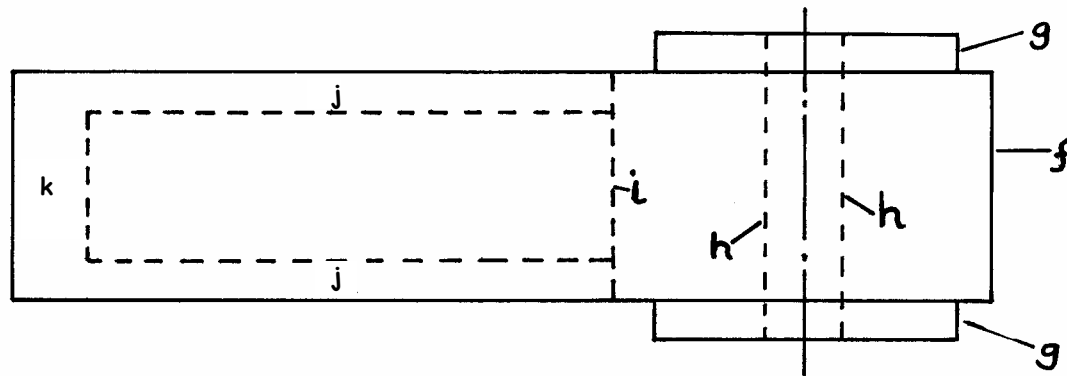
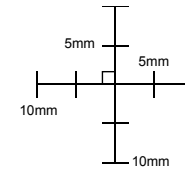
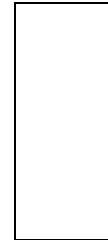

Question 6

- (a) Crate size (l, b, h), 2 for 1 mark, 3 for 2 marks 2
- (b) Height 80 1
- (c) Step 5 1
- (d) Height 10 1
- (e) Line 5 1
- (f) Sloping lines 1
- (g) Slot (size and position) 1
- (h) Part circle 1
- (i) Circle (size and position) 1
- (j) Lines 1
- (k) Part circles 1

Total DA 12

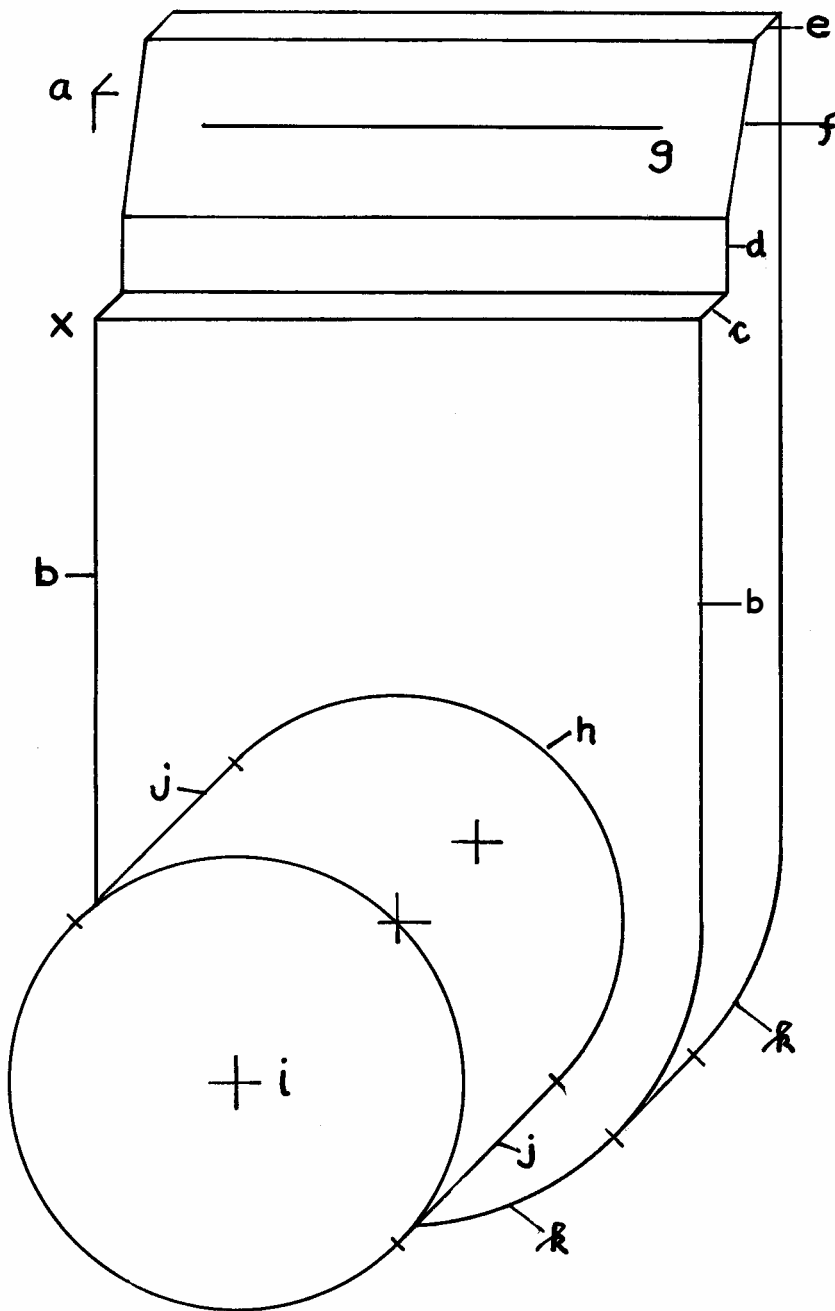
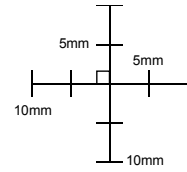
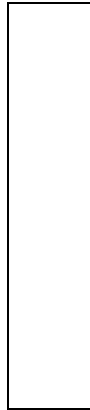

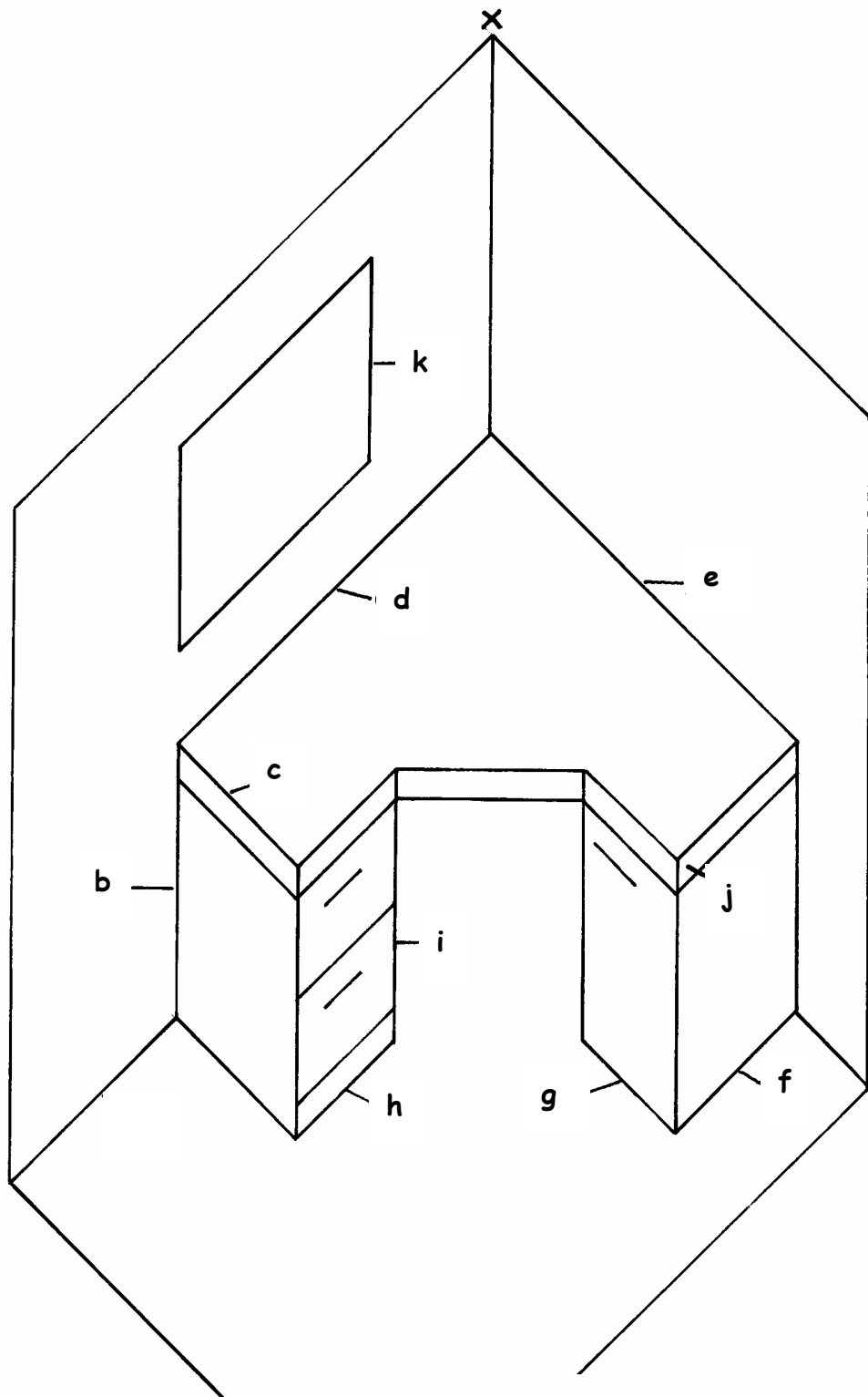

Question 7

- | | | |
|-----|-----------------------------------|---|
| (a) | Crate LBH (2 out of 3 for 1 mark) | 2 |
| (b) | Height 40 | 1 |
| (c) | Drawer unit width 25 | 1 |
| (d) | Desk length 65 | 1 |
| (e) | Length | 1 |
| (f) | Breadth | 1 |
| (g) | Cupboard length | 1 |
| (h) | Drawers breadth | 1 |
| (i) | Drawers shown and handles | 1 |
| (j) | Thicknesses shown (3 out of 5) | 1 |
| (k) | Window size and position | 1 |

Total DA 12

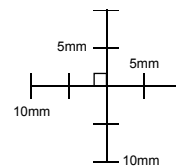
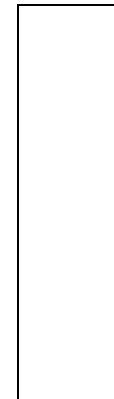

Question 8

Plan

- (a) Length of edge (both needed) 1
- (b) Length of edge (both needed) 1
- (c) Breadth of flat 1
- (d) Sloping lines (four from eight – 1 mark) 2
- (e) Breadth and position 1
- (f) Broken lines (four needed) 1

Total DA 7

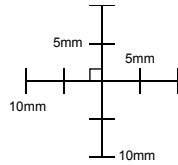

True shape

- (g) True length and correct projection 1
- (h) Breadth (one needed) 1
- (i) Breadth A/C 1
- (j) Sloping lines (four needed) 1

Total DA 4

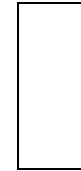

9

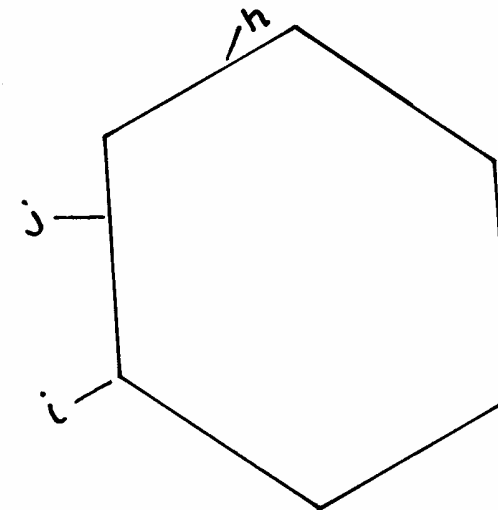
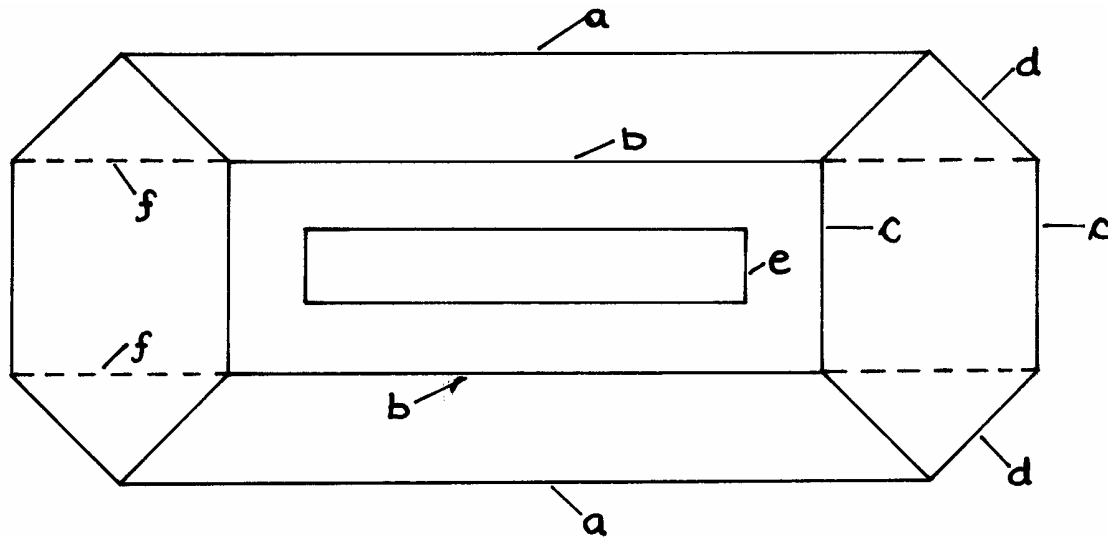

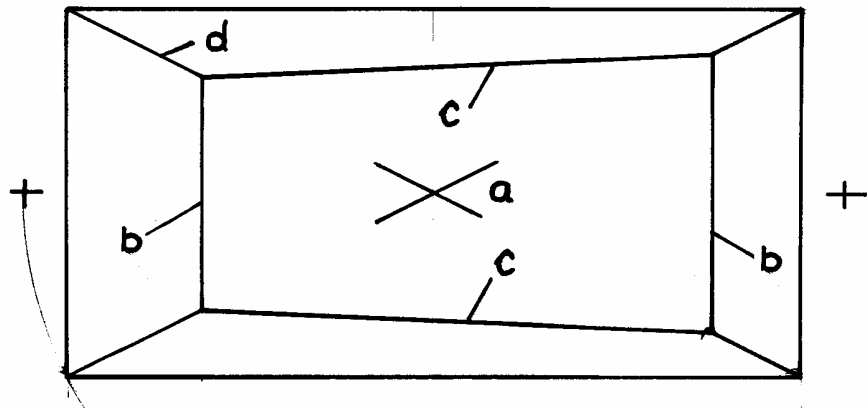

Question 9

- (a) Edges drawn to correct apex 1
 - (b) Cut proj from elevation (both needed) 1
 - (c) Cut surface shown 1
 - (d) Edges of pyramid outlined (four needed) 1
- DA 4**

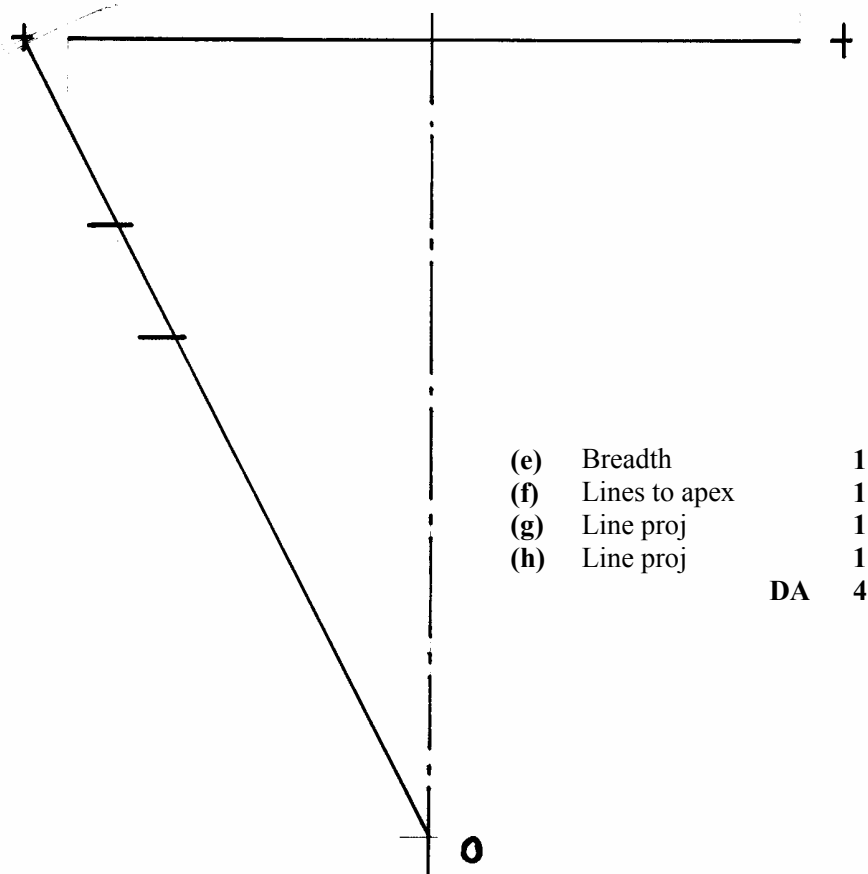
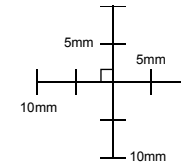
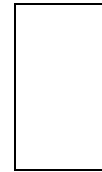

- (e) Breadth 1
 - (f) Lines to apex 1
 - (g) Line proj 1
 - (h) Line proj 1
- DA 4**

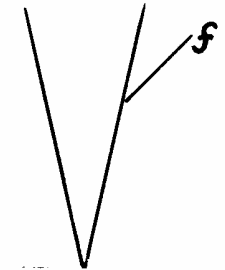
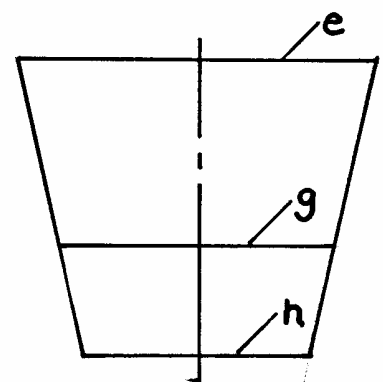
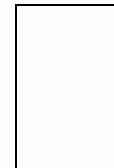

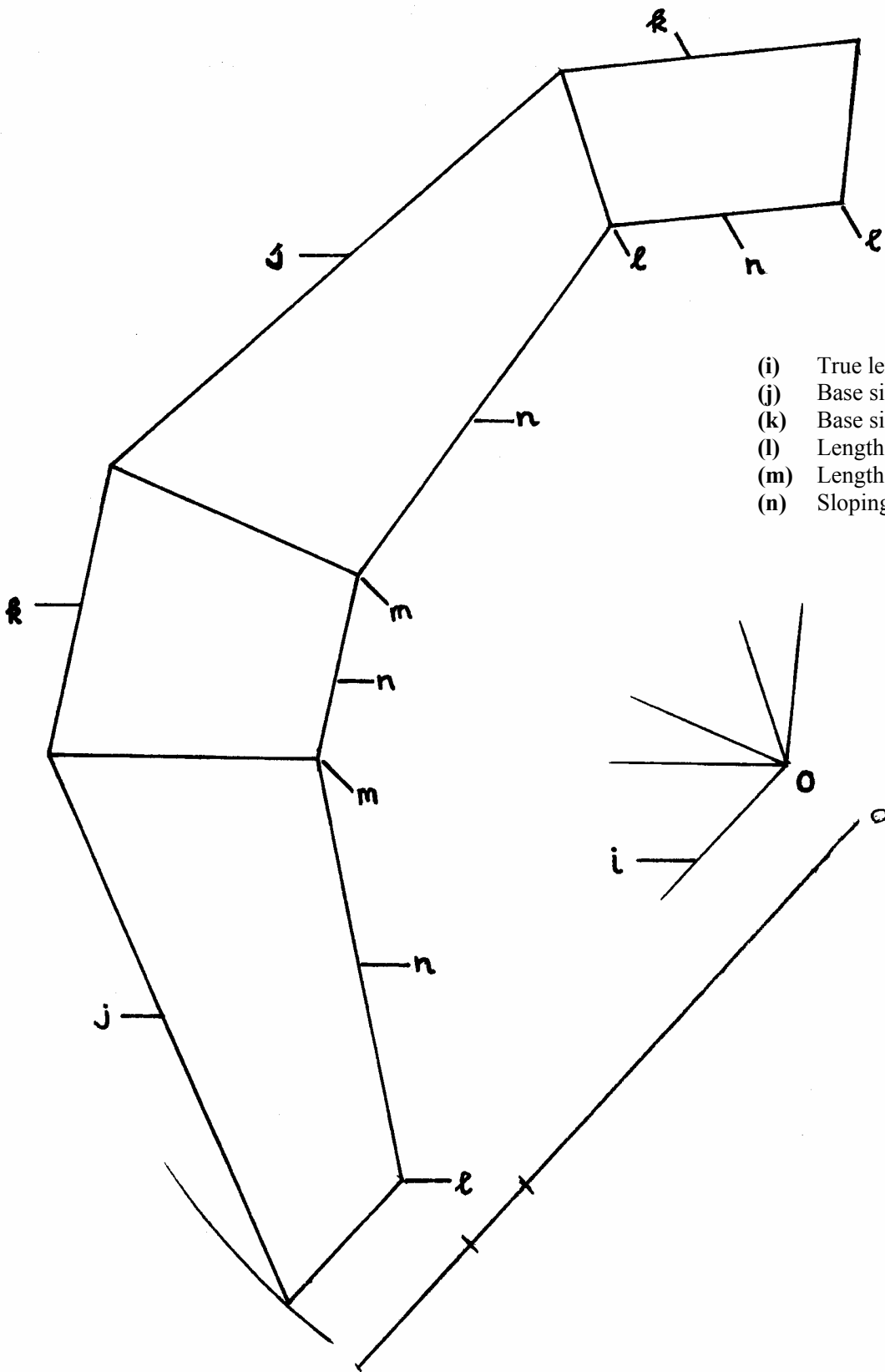

(i)	True length correct	1
(j)	Base sizes 100 (both)	1
(k)	Base sizes 50 (both)	1
(l)	Length	1
(m)	Length	1
(n)	Sloping lines shown	1
	DA	6
	TOTAL DA	14

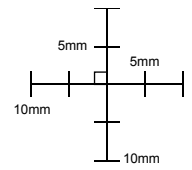
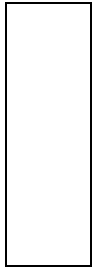

[END OF MARKING INSTRUCTIONS]