



NQ
NATIONAL
QUALIFICATIONS

Technological Studies

Data Booklet

Standard Grade and
Intermediate 2

 **SQA**

Technological Studies Data Booklet

Standard Grade and Intermediate 2

For use in National Qualification Courses
leading to the 2009 examinations and beyond.

Published date: July 2008
Publication code: BB4469
ISBN: 978 1 85969 603 3

Published by the Scottish Qualifications Authority
The Optima Building, 58 Robertson Street, Glasgow G2 8DQ
Ironmills Road, Dalkeith, Midlothian EH22 1LE

www.sqa.org.uk

The information in this publication may be reproduced in support of SQA qualifications. If it is reproduced, SQA should be clearly acknowledged as the source. If it is to be used for any other purpose, then written permission must be obtained from the Publishing Team at SQA. It must not be reproduced for trade or commercial purposes.

© Scottish Qualifications Authority 2008

For an up-to-date list of prices visit the **Publication Sales and Downloads** section of SQA's website.

This document can be produced, on request, in alternative formats, including large type, braille and numerous community languages.

For further details telephone SQA's Customer Contact Centre on 0845 279 1000.

Contents

Preface	1
Quantities, Symbols and Units	2
Decimal Prefixes	3
Relationships	4
Pneumatic Systems	4
Energy and Power	5–6
Mechanical Systems	7
Electrical/Electronic	8
Resistor Colour Code	9
7400 series IC Pinout Diagrams	10
Graphs for Thermistors and LDR	11
Thermistors	11
Light Dependant Resistor (LDR)	12
Binary Weighting of Data Lines	13
Symbols for Flowcharts	14
PBASIC Instruction Set	15

Preface

This data booklet is intended for use by candidates in examinations in Technological Studies at Standard Grade and Intermediate 2. It is recommended that candidates should become familiar with the contents of the data booklet through use in undertaking units of these courses.

It should be noted that the range of data contained in the booklet has been limited to that syllabus content which may be assessed through written examination papers. This range should be supplemented by other resource material as necessary during the course, eg by using data sheets. However, should any additional information (or data not included in this booklet) be required in an examination, such information will be included in the examination paper.

Teachers/lecturers should note that all of the material contained in this booklet is likely to be examined at some time. With regard to tables of information, not every entry in a table will necessarily be involved in examination questions.

From the variety of data offered in this booklet, candidates will be expected to demonstrate the ability to select an appropriate:

- item of information
- formula
- material property
- operational amplifier circuit
- PBASIC instruction

Quantities, Symbols and Units

Quantity	Symbol	Unit	Abbreviation
distance	s, x	metre	m
height	h	metre	m
diameter	d	metre	m
radius	r	metre	m
area	a	square metre	m ²
circumference	c	metre	m
time	t	second	s
speed, velocity	v	metre per second	m/s
mass	m	kilogram	kg
weight	W	newton	N
force	F	newton	N
gravitational acceleration	g	metres per second squared	m/s ²
work done	W or E _w	joule	J
energy	E	joule	J
power	P	watt	W
torque	T	newton metre	Nm
efficiency	η	–	–
pressure	P	newton per square metre	N/m ²
temperature	T, t	kelvin, celsius	K, °C
specific heat capacity	c	joule per kilogram degree kelvin	J/kgK
voltage, potential difference	V	volt	V
current	I	ampere (amp)	A
resistance	R	ohm	Ω
transistor current gain	h _{FE}	–	–
frequency	f	hertz	Hz
capacitance	C	farad	F

Decimal Prefixes

Prefix	Symbol	Multiplying factor
tera	T	10^{12}
giga	G	10^9
mega	M	10^6
kilo	k	10^3
milli	m	10^{-3}
micro	μ	10^{-6}
nano	n	10^{-9}
pico	p	10^{-12}

Relationships

Pneumatic Systems

Pressure, force & area

$$P = \frac{F}{A}$$

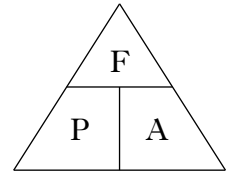

Area of circle

$$A = \frac{\pi d^2}{4}$$

$$d = \sqrt{\frac{4A}{\pi}}$$

$$\pi = 3.14$$

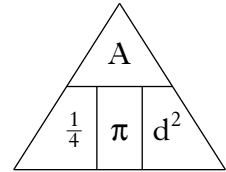

$$A = \pi r^2$$

$$r = \sqrt{\frac{A}{\pi}}$$

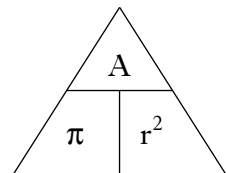

Energy and Power

Potential energy

$$E_p = mgh$$

$$g = 9.81 \text{ m/s}^2$$

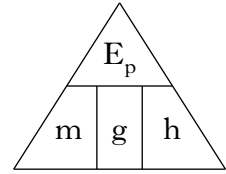

Kinetic energy

$$E_k = \frac{1}{2}mv^2$$

$$v = \sqrt{\frac{2E_k}{m}}$$

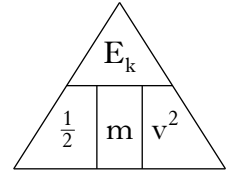

Strain energy

$$E_s = \frac{1}{2}Fx$$

$$F = \frac{2E_s}{x}$$

$$x = \frac{2E_s}{F}$$

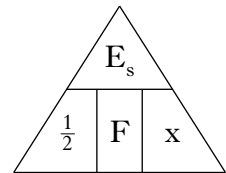

Electrical energy

$$E_e = VIt$$

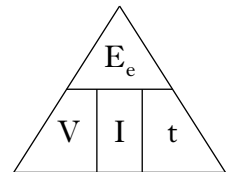

Heat energy

$$E_h = cm\Delta T$$

$$c_{\text{water}} = 4190 \text{ J/kgK}$$

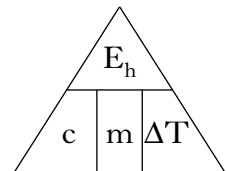

Work done

$$W = Fs$$

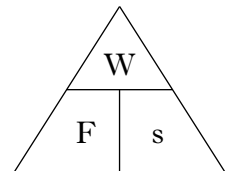

Power

$$P = \frac{E}{t} \text{ or } \frac{W}{t}$$

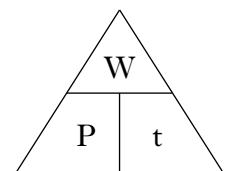
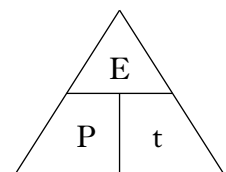

Electrical power

$$P = VI \text{ or } \frac{V^2}{R} \text{ or } I^2R$$

$$V = \sqrt{PR}$$

$$I = \sqrt{\frac{P}{R}}$$

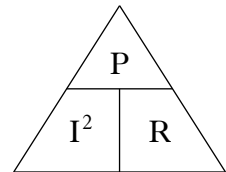
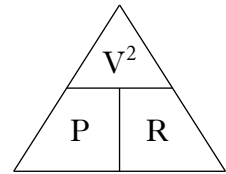
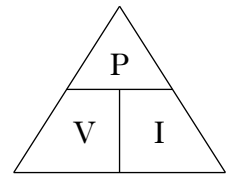

Mechanical power

$$P = Fv$$

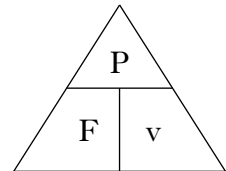

$$P = 2\pi nT$$

$$\pi = 3.14$$

n is speed in rev/s

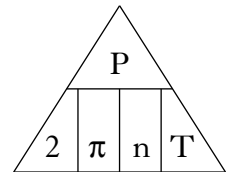

Efficiency

$$\eta = \frac{\text{Output Energy}}{\text{Input Energy}}$$

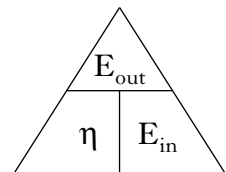

$$\eta = \frac{\text{Output Power}}{\text{Input Power}}$$

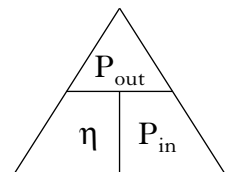

Mechanical Systems

Velocity Ratio

$$VR = \frac{\text{speed of input}}{\text{speed of output}}$$

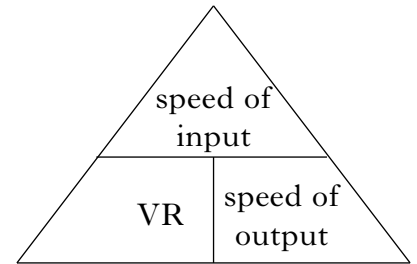

Torque

$$T = Fr$$

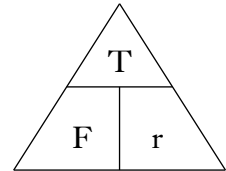

Circumference of circle

$$c = \pi d$$

π is 3.14

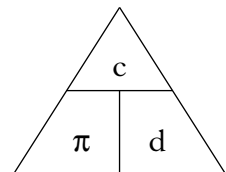

Moment of force

$$M = Fx$$

x is the perpendicular distance

Principle of moments

$$\Sigma M = 0 \quad \text{or}$$

$$\Sigma \text{CWM} = \Sigma \text{ACWM}$$

Conditions of equilibrium

$$\Sigma F_h = 0$$

$$\Sigma F_v = 0$$

$$\Sigma M = 0$$

Electrical/Electronic

Ohm's law

$$V = IR$$

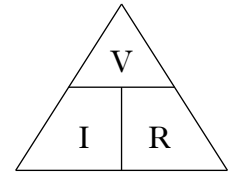

Resistors in series

$$R_t = R_1 + R_2 + R_3 + \dots$$

Resistors in parallel

$$\frac{1}{R_t} = \frac{1}{R_1} + \frac{1}{R_2} + \frac{1}{R_3} + \dots$$

for 2 resistors in parallel

$$R_T = \frac{R_1 R_2}{(R_1 + R_2)} \quad \left(R_T = \frac{\text{product}}{\text{sum}} \right)$$

Kirchoff's 1st Law
(parallel branch)

$$I_t = I_1 + I_2 + I_3 + \dots \quad \left(\begin{array}{l} \sum I = 0 \\ \text{Algebraic sum of} \\ \text{currents at node is zero} \end{array} \right)$$

Kirchoff's 2nd Law
(series circuit)

$$V_t = V_1 + V_2 + V_3 + \dots \quad \left(\begin{array}{l} \sum E = 0 \\ \text{Algebraic sum of} \\ \text{supply voltages = sum} \\ \text{of voltage drops, in a} \\ \text{closed loop} \end{array} \right)$$

Voltage Divider

$$\frac{V_1}{V_2} = \frac{R_1}{R_2} \quad \text{or} \quad V_1 = \frac{R_1}{R_t} \times V_s$$

Bi-polar transistor gain

$$h_{FE} = \frac{I_c}{I_b}$$

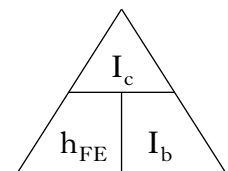

Saturated Transistor

$$V_{be} = 0.7 \text{ V}$$

Resistor Colour Coding

4 Band Resistor Colour Code Layout

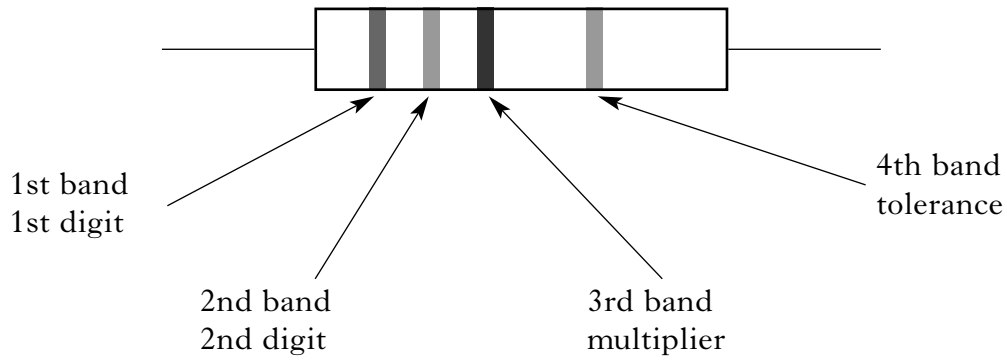

1st and 2nd Colour Band	Digit	Multiplier
Black	0	$\times 1$
Brown	1	$\times 10$
Red	2	$\times 100$
Orange	3	$\times 1000$ or 1 k
Yellow	4	$\times 10\,000$ or 10 k
Green	5	$\times 100\,000$ or 100 k
Blue	6	$\times 1\,000\,000$ or 1 M
Violet	7	Silver is divide by 100
Grey	8	Gold is divide by 10
White	9	Tolerances: <ul style="list-style-type: none"> • Brown 1% • Red 2% • Gold 5% • Silver 10% • None 20%

7400 series IC Pinout Diagrams

7400

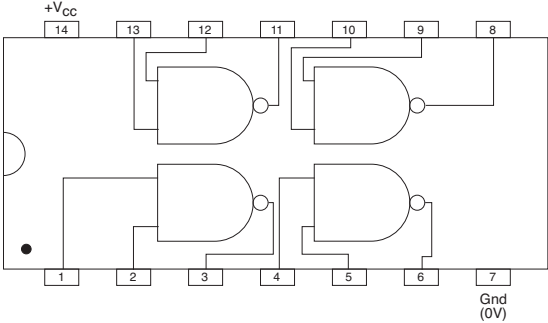

7402

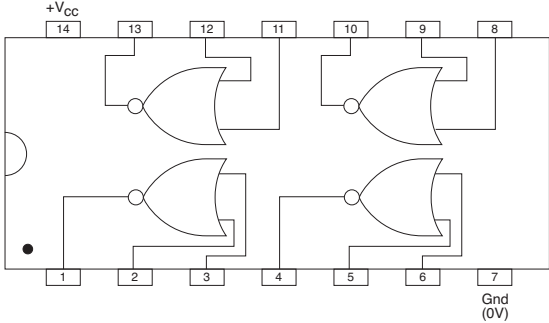

7404

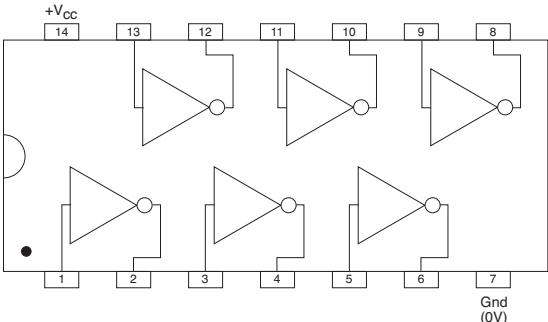

7408

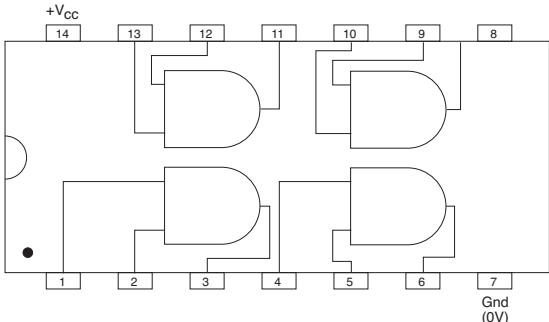

7432

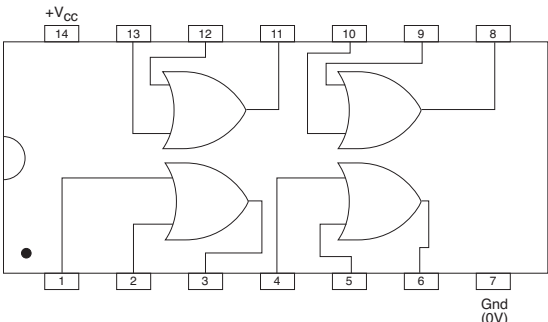

Graphs for Thermistors and LDR

Thermistors

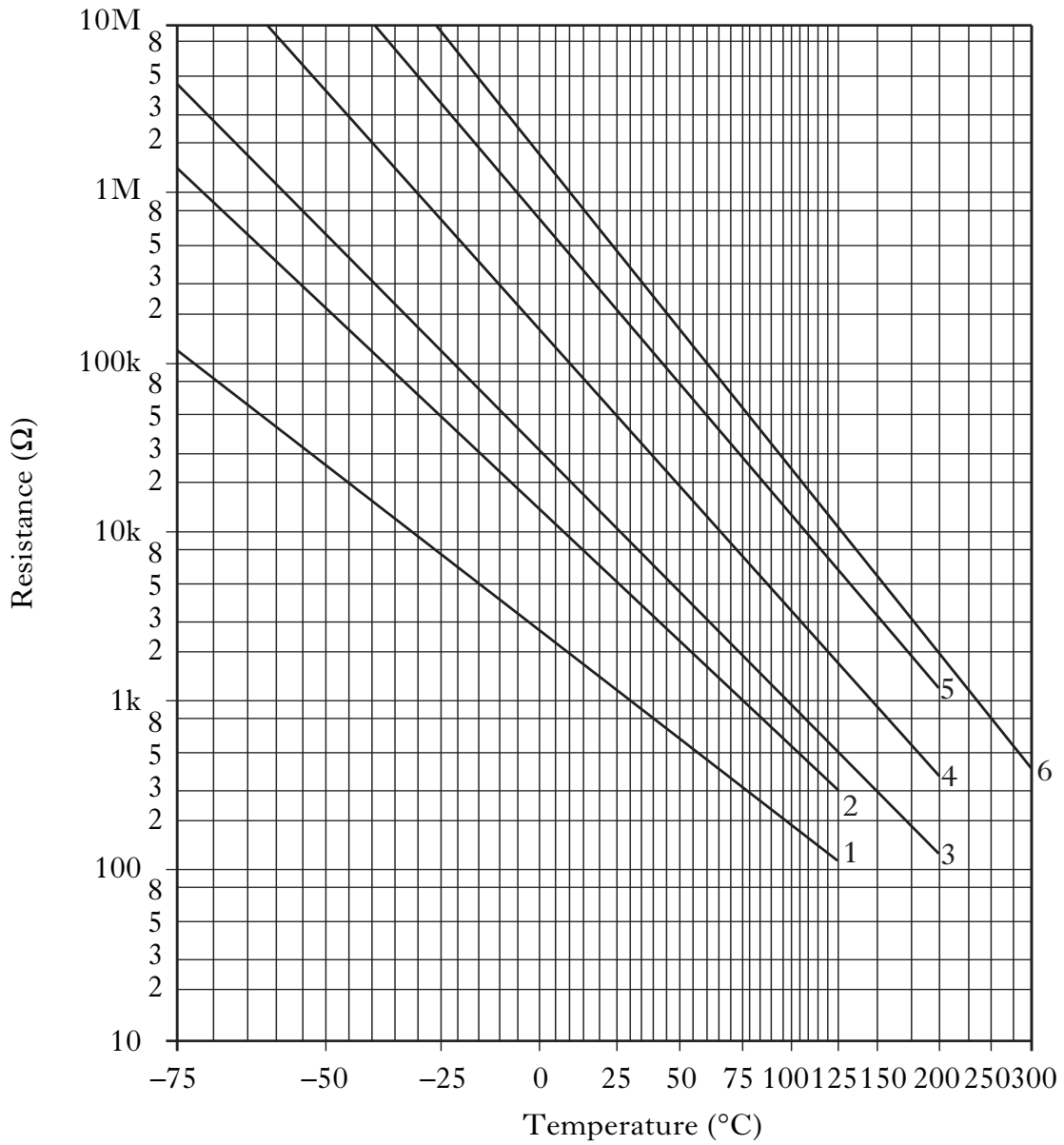

Light Dependent Resistor (LDR)

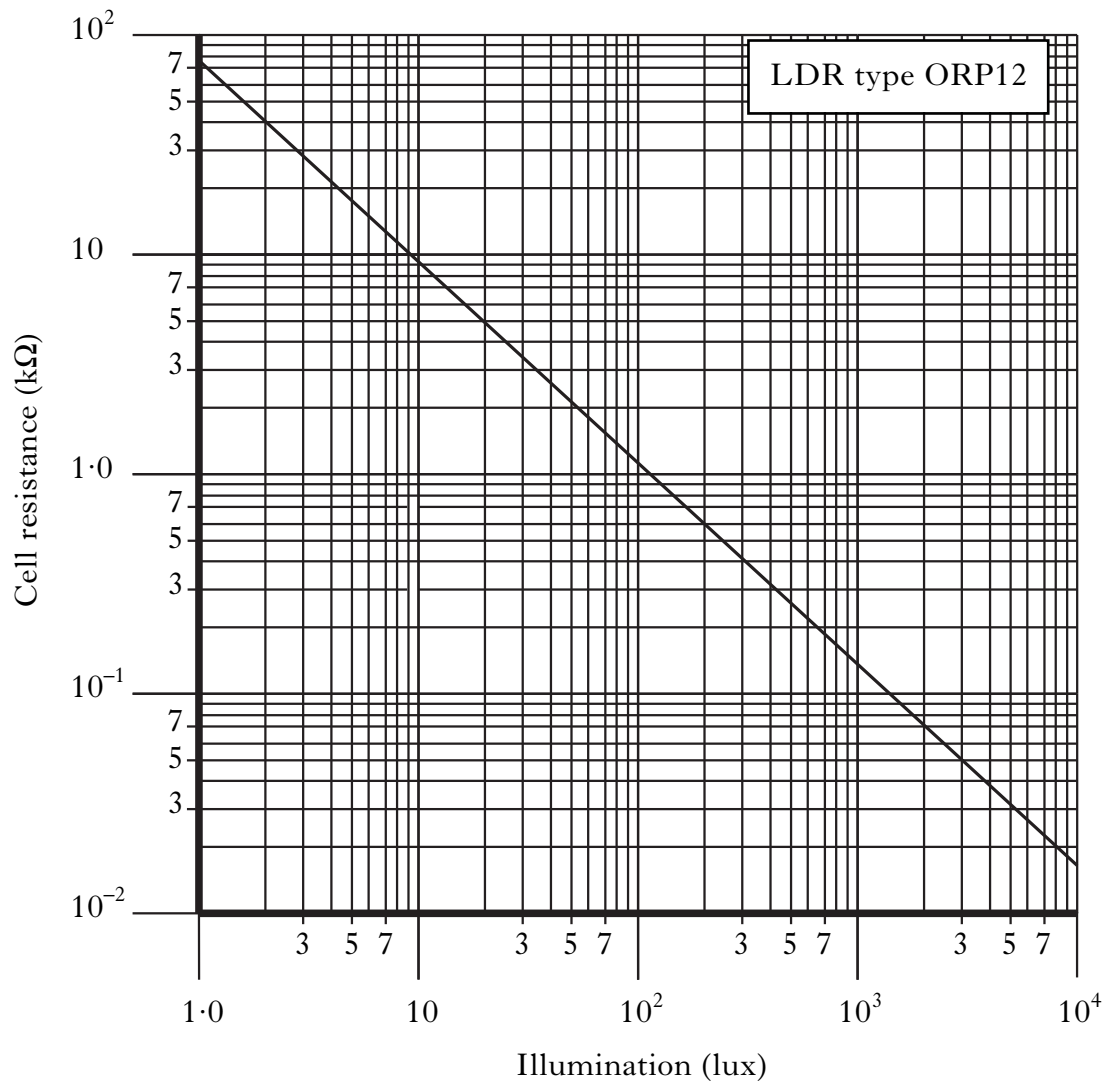

Binary Weighting of Data Lines

bit	7	6	5	4	3	2	1	0
	2^7	2^6	2^5	2^4	2^3	2^2	2^1	2^0
weighting	128	64	32	16	8	4	2	1

Decimal to Binary conversion

Decimal	Binary
0	0000
1	0001
2	0010
3	0011
4	0100
5	0101
6	0110
7	0111
8	1000
9	1001
10	1010
11	1011
12	1100
13	1101
14	1110
15	1111

Symbols for Flowcharts

Terminator symbol



Used for the start and end of a main program or sub-procedure.

Line symbol



Shows the direction of program flow.

For flow down or to the right an arrow is not needed.

For flow upwards or to the left arrows are added.

Input/Output



Used to control outputs or to show that data is being received.

Process symbol



Used for operations which take place within the microcontroller, for example a delay.

Decision symbol

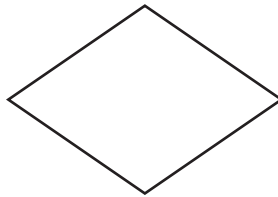

Program flow is determined by a “yes” or “no” answer to the question in the box.

Sub procedure symbol



Used to call a sub-procedure.

PBASIC Instruction Set

PBASIC Instruction	Explanation
symbol	Allocate a name to a pin or variable
let	Allocate variables using mathematic equations
INPUT/OUTPUT	
high <i>x</i>	Set pin “ <i>x</i> ” high
low <i>x</i>	Set pin “ <i>x</i> ” low
dirs	Set pins on PORTB to input or output
pins	Set level of all pins at once
sensor	Converts analogue input (A or B) into a scaled value 1–240
TIME	
pause <i>n</i>	Create a time delay of <i>n</i> in milliseconds (0–65535)
PROGRAM FLOW	
goto <i>label</i>	Jump to <i>label</i>
gosub <i>label</i>	Jump to sub-procedure at <i>label</i>
return	Return from sub-procedure
if then <i>label</i>	If a condition is met, jump to a <i>label</i> (but not a sub-procedure)
for next	Set a loop which repeats a specific number of times
end	End program

The default number system is decimal.
For binary numbers, the prefix “%” is used.

Variables

The *byte* variables (b0–b13) can store values between 0 and 255.

The *word* variables (w0–w5) can store values between 0 and 65535; w0 contains b0 and b1 within it; w1 contains b2 and b3 within it etc.



Customer Contact Centre

T: 0845 279 1000 E: customer@sqa.org.uk W: www.sqa.org.uk

BB4469

July 2008

ISBN: 978 1 85969 603 3