

Guidelines for Question Paper Artwork



Graphic Artists at Your Service!

Guidelines for Question Paper Artwork

SQA's Graphic Artists produce all the artwork required for SQA's question papers. This includes drawings, graphs, scans, photographs, charts, maps and diagrams. We have created these guidelines to help us better understand your needs and produce appropriate high quality graphics.

Look out for helpful hints throughout this booklet.

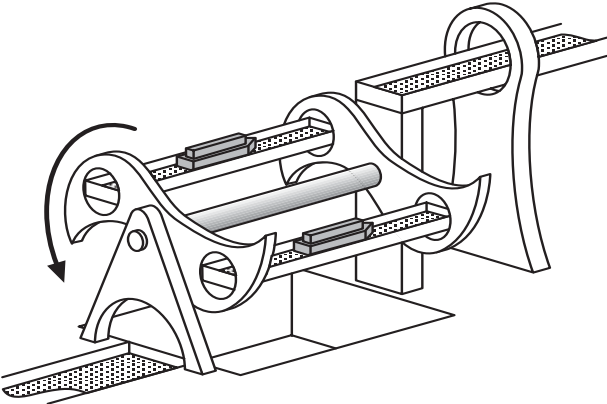

Supplying artwork - important information

- 1) Please be as detailed as possible in defining what kind of artwork is required, for example, photograph, line drawing, cartoon, realistic. If the style or content is not important please state this.
- 2) Please provide information on the primary source of the image, for example,
 - ✓ the exact website address of the image if from the Internet
 - ✓ the book/magazine it was taken from (please include these items with the draft).

Without the source information we have no means of finding the image, so in a lot of cases we would need to find a replacement. Source information is also required for copyright clearance purposes.

- 3) If you are providing paper copies of images for inclusion in the question papers these need to be as good a quality as possible. It is unlikely that the quality can be improved through scanning a poor image and it may even be worse.



People/figures

What medium of artwork do you require?

Photograph?

Line drawing?

Cartoon?

Tonal drawing?

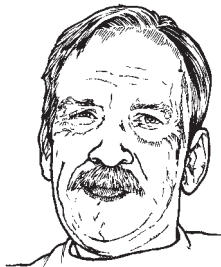

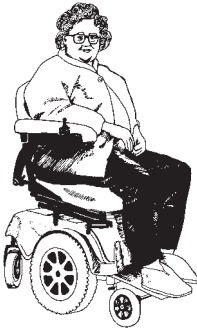

Give details about the person/people

- Male/Female?
- Age bracket?
- Happy/sad?
- Ethnic origin



What should be included in the artwork?

- Head/head and shoulders/full body?
- Standing/sitting pose?
- What size of picture?
- Is a background scene necessary, or can the person be on their own?

Please give as many details as possible, if none are important please state this.



Graphs

We use standard line widths to meet print requirements. We will use these standard line widths unless you request otherwise. We cannot print lines any finer than 0.2mm.

Please state:

- ✓ The size of the graph grid required, ie how many horizontal and vertical grid lines you would like
- ✓ If there are any exact points that must be plotted on the graph, and what they are.

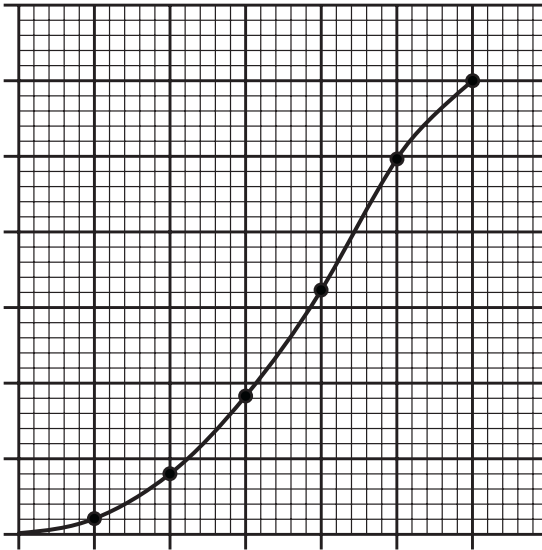

Remember to give us as much detail as possible on the type of graph or chart you require.

Please bear in mind that the printed graphs you will see in proof copies will appear to have thicker lines than in the final print. This is because our laser printers cannot print to the same degree of refinement as the commercial print systems used for the final question paper.

Photographs

If supplying us with electronic photographs or scans please use file formats such as **.jpg** or **.tif** and save them directly onto a disc. If you are unsure about how to do this please contact us.

Please **do not** embed or paste photographs or scans into Microsoft Word documents, as this reduces the image quality considerably!

Modern Language Question Papers

Quite often we are asked to create images to go with a passage of foreign language text containing information on, say, 4 different people. As we probably don't speak the language, you'll need to tell us the details of the people to be illustrated!

Information about our software programs and Information Technology

Programs/IT used/available to us

- Adobe Photoshop 7
- Adobe Illustrator CS3
- Macromedia Freehand 10
- Microsoft Word
- Microsoft Excel
- Microsoft PowerPoint
- QuarkXPress 5
- A4/A3 Scanners
- Internet access
- Email

File types for artwork

- .jpeg
- .tif
- .eps

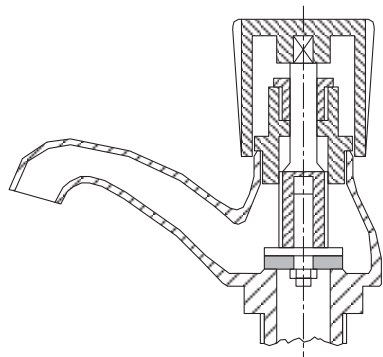

About our team

The Graphic Artist team at SQA are all experienced, qualified illustrators and designers. Many of us have specialist skills and illustration styles.

SQA's Graphic Artists are:

Lisa Robertson

Senior Graphic Artist

Tel: 0131-561 6809

E-mail: lisa.l.robertson@sqa.org.uk

Craig Mitchell

Graphic Artist

Tel: 0131-271 6740

E-mail: craig.mitchell@sqa.org.uk

Alan McIntosh

Graphic Artist

Tel: 0131-271 6740

E-mail: alan.mcintosh@sqa.org.uk

Sarah Batey

Graphic Artist

E-mail: sarah.batey@sqa.org.uk

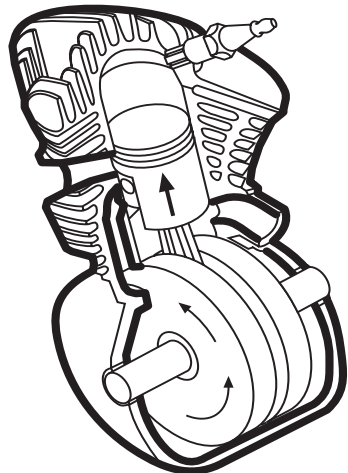
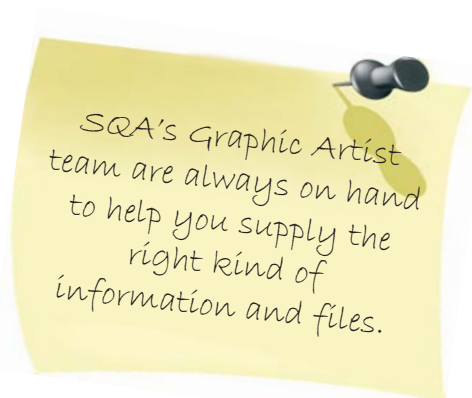
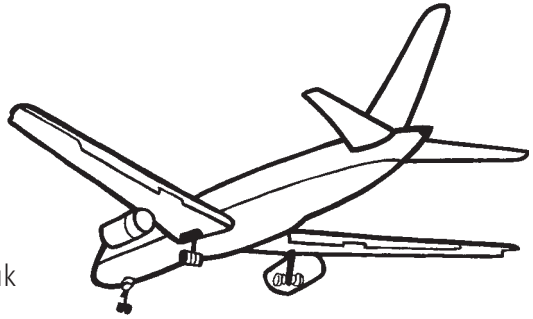



Customer Contact Centre
T: 0845 279 1000 E: customer@sqa.org.uk W: www.sqa.org.uk
FA4549 July 2009

