

FOR OFFICIAL USE

--	--	--	--	--	--

Total Mark

--

NATIONAL QUALIFICATIONS 2014

# MATHEMATICS INTERMEDIATE 1

Units 1, 2 and 3  
Paper 2



\* X 1 0 0 1 0 0 2 \*

## X100/10/02

TUESDAY, 6 MAY 9.55 AM – 10.50 AM

Fill in these boxes and read what is printed below.

Full name of centre

Town

--

--

Forename(s)

Surname

Number of seat

--

--

--

Date of birth

Day

Month

Year

Scottish candidate number

--	--

--	--

--	--

--	--	--	--	--	--	--	--	--	--

1 You may use a calculator.

2 Write your working and answers in the spaces provided. Additional space is provided at the end of this question-answer book for use if required. If you use this space, write clearly the number of the question involved.

3 Full credit will be given only where the solution contains appropriate working.

4 Before leaving the examination room you must give this book to the Invigilator. If you do not you may lose all the marks for this paper.

Use blue or black ink. Pencil may be used for graphs and diagrams only.



\* X 1 0 0 1 0 0 2 0 1 \*

## FORMULAE LIST

Circumference of a circle:

$$C = \pi d$$

Area of a circle:

$$A = \pi r^2$$

Theorem of Pythagoras:

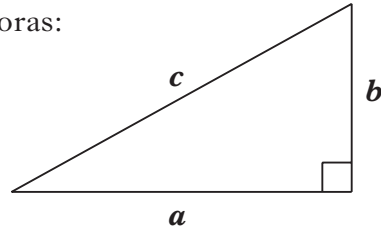

$$a^2 + b^2 = c^2$$

Trigonometric ratios  
in a right angled  
triangle:

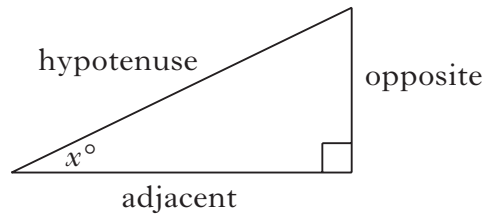

$$\tan x^\circ = \frac{\text{opposite}}{\text{adjacent}}$$

$$\sin x^\circ = \frac{\text{opposite}}{\text{hypotenuse}}$$

$$\cos x^\circ = \frac{\text{adjacent}}{\text{hypotenuse}}$$



**All questions should be attempted.**

1. Peter makes his own orange juice.

The amount of juice he can make is proportional to the number of oranges he uses.

He uses 8 oranges to make 500 millilitres of juice.

How much juice can he make with 14 oranges?

2

2. The thickness of a sheet of gold leaf is 0.000013 centimetres.

Write this number in standard form.

2

3. Solve algebraically the inequality

$$5u + 21 < 86.$$

2



Marks

4. The fuel consumption, in miles per gallon, of twenty one cars is shown below.

62	36	54	31	45	27	46
29	39	33	50	42	53	28
36	32	30	44	38	34	41

- (a) Display the information in a stem and leaf diagram.

- (b) Find the median fuel consumption in miles per gallon.

- (c) Find the range.

3

1

1



Marks

5. (a) Multiply out the brackets and simplify

$$13x + 6(2y - x).$$

2

- (b) Factorise

$$14 - 63g.$$

2

[Turn over



Marks

6. A water tank is in the shape of a cuboid with dimensions as shown.

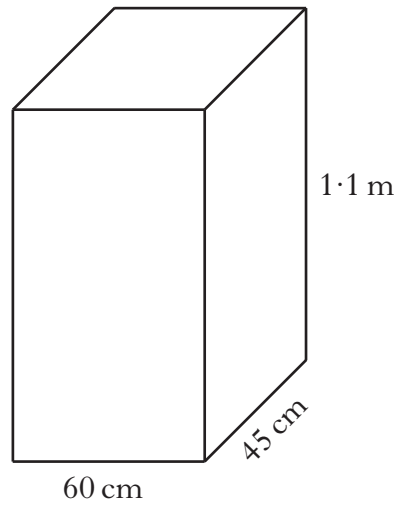

Calculate the volume of the tank.  
Give your answer in litres.  
(1 litre = 1000 cubic centimetres.)

3



Marks

7. Katy drove 351 miles from Perth to Birmingham.  
Her average driving speed was 52 miles per hour.  
She also had two 40 minute stops during the journey.  
She left Perth at 1730.  
When did she arrive in Birmingham?

4

8. When booking a holiday to Canada, Anna paid £50 for a boat trip.  
When she was in Canada she saw the same boat trip advertised for  
85 Canadian dollars.  
The exchange rate was £1 = 1.57 Canadian dollars.  
How much did she save, **in pounds and pence**, by paying for the  
boat trip before going to Canada?

3



Marks

9. The pie chart shows the results of a customer satisfaction survey carried out by Red Talk Media, a broadband service provider, in 2012.

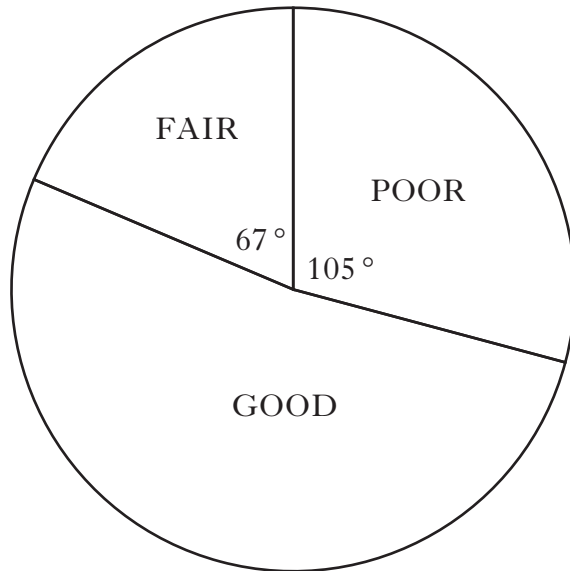

- (a) A total of 3420 customers took part in the survey.  
How many customers said that the service provided was good?

3





Marks

9. (continued)

Red Talk Media repeated the customer satisfaction survey in 2013. The results are shown in the pie chart below.

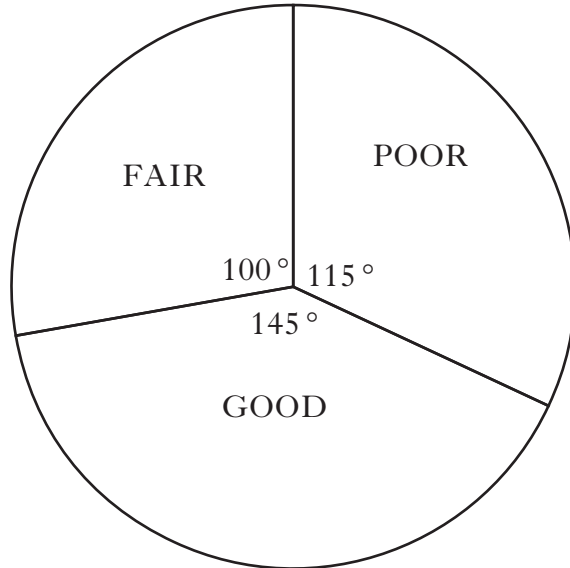

(b) Make **two** comments comparing the results in 2013 with those in 2012.

2

[Turn over



Marks

10. Jo is making a patchwork cushion.

Each patch is a right-angled triangle with both short sides 12 centimetres long.

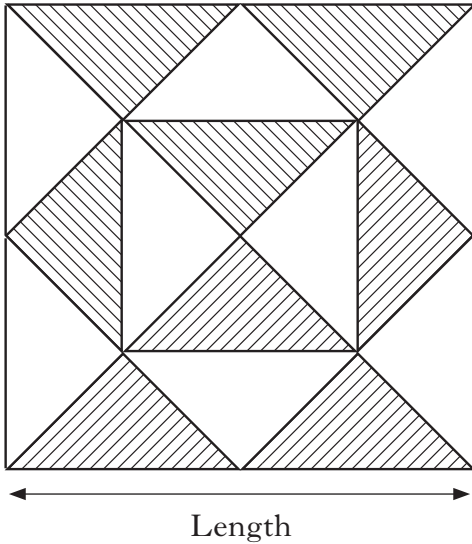
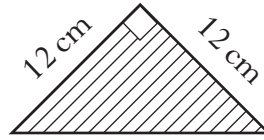

She makes the cushion by arranging the patches as shown.

Calculate the length of the cushion.

**Do not use a scale drawing.**

4



*Marks*

11. Roy invested £980 in a bank account.  
The rate of interest was 1·8% per annum.  
How much interest was he due after five months?

3

[Turn over



Marks

12. In shape PQRS, side PQ is 8 centimetres and side PS is 17 centimetres as shown.

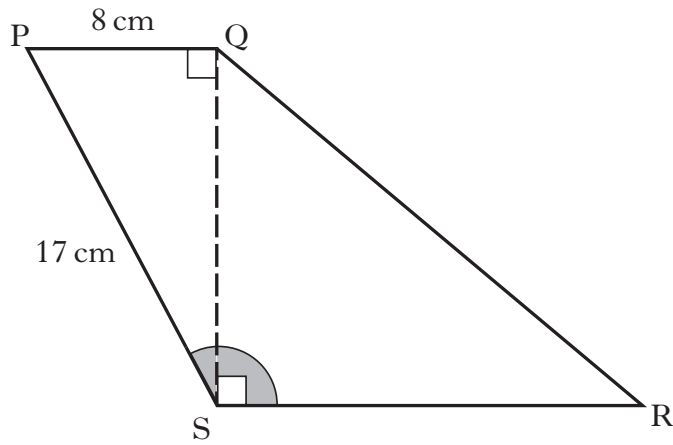

Calculate the size of the shaded angle PSR.

**Do not use a scale drawing.**

4



*Marks*

13. Alan is growing a sunflower.  
One week its height increased from 75 centimetres to 81 centimetres.  
Calculate the percentage increase in the sunflower's height.



4

[Turn over for Question 14 on *Page fourteen*]



Marks

14. The plan of a patio is shown below.

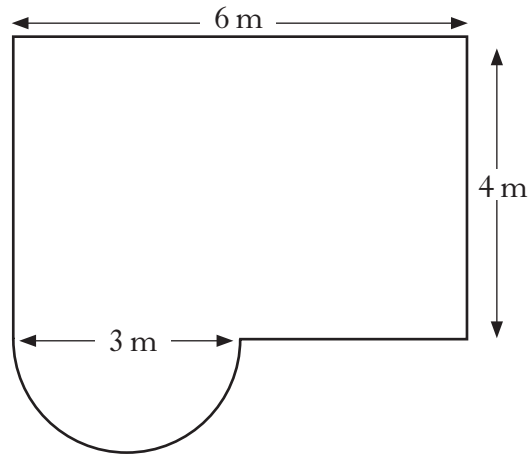

The patio consists of a rectangle and a semi-circle.

Calculate the area of the patio.

Give your answer correct to the **nearest square metre**.

5

[END OF QUESTION PAPER]



ADDITIONAL SPACE FOR ANSWERS

DO NOT  
WRITE IN  
THIS  
MARGIN

--	--



ADDITIONAL SPACE FOR ANSWERS

DO NOT  
WRITE IN  
THIS  
MARGIN

--	--





## ACKNOWLEDGEMENT

Question 13 – 53598778 Shutterstock.com