



Design and Manufacture Data Booklet

National 5, Higher and Advanced Higher

This edition: September 2019, version 1.2

Published by the Scottish Qualifications Authority
The Optima Building, 58 Robertson Street, Glasgow G2 8DQ
Lowden, 24 Wester Shawfair, Dalkeith, Midlothian EH22 1FD

www.sqa.org.uk

© Scottish Qualifications Authority 2019

Contents

Anthropometric data

- Standing and seated figures 4
- Hand and head 5
- Wheelchair 5

Production costs

- Manufacturing processes 6
- Fabrication costs 7
- Assembly costs 7

Stock material sizes and costs

- Dressed timber, man-made boards and dowelling 8
- Metal sections and sheets 9
- Plastic sections, granules and sheets 10

Fixings

- Threaded bar, nuts, bolts and washers 12
- Screws 12
- Pop rivets 12

Anthropometric data

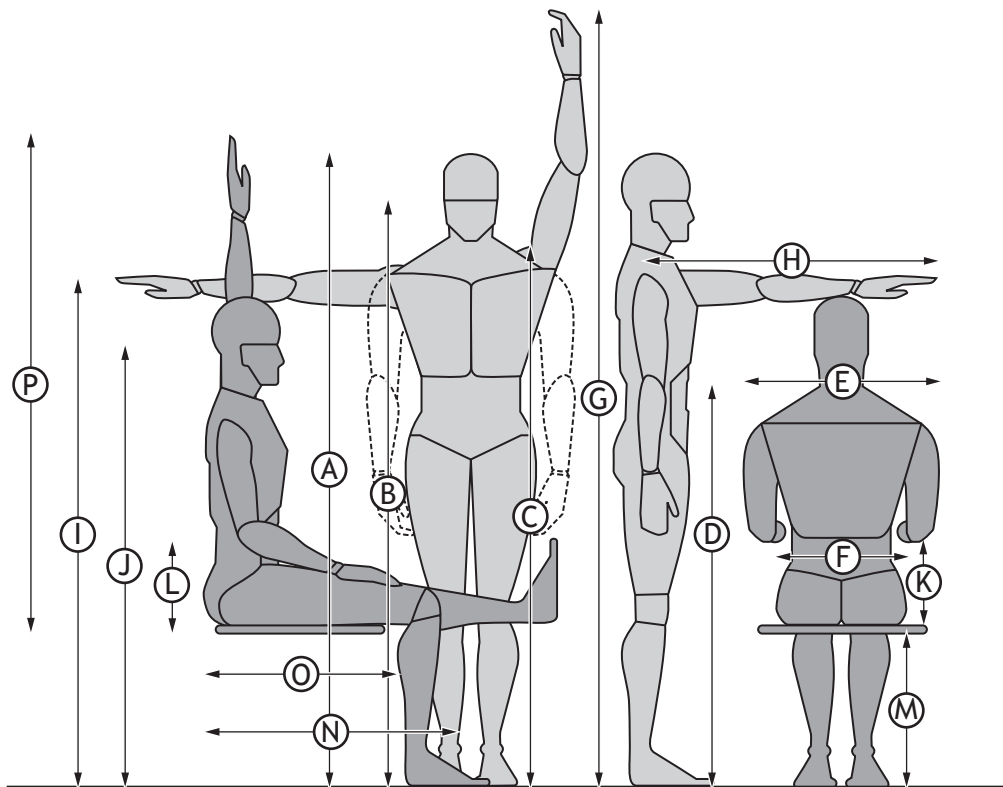

| Standing and seated figures | | Adult male | | | Adult female | | | 4-year-old child | | | 16-year-old boy | | | 16-year-old girl | | |
|-----------------------------|---------------------------|-----------------|------------------|------------------|-----------------|------------------|------------------|------------------|------------------|------------------|-----------------|------------------|------------------|------------------|------------------|------------------|
| | | Percentile | | | Percentile | | | Percentile | | | Percentile | | | Percentile | | |
| | | 5 th | 50 th | 95 th | 5 th | 50 th | 95 th | 5 th | 50 th | 95 th | 5 th | 50 th | 95 th | 5 th | 50 th | 95 th |
| A | Height | 1642 | 1756 | 1870 | 1515 | 1621 | 1827 | 974 | 1053 | 1133 | 1609 | 1735 | 1861 | 1484 | 1601 | 1818 |
| B | Eye level | 1528 | 1641 | 1754 | 1410 | 1516 | 1616 | 872 | 951 | 1030 | N/A | N/A | N/A | N/A | N/A | N/A |
| C | Shoulder height | 1345 | 1451 | 1556 | 1231 | 1330 | 1429 | 749 | 828 | 906 | 1240 | 1439 | 1555 | 1135 | 1319 | 1428 |
| D | Elbow height | 1021 | 1107 | 1192 | 948 | 1021 | 1094 | 552 | 607 | 662 | N/A | N/A | N/A | N/A | N/A | N/A |
| E | Shoulder width | 443 | 484 | 537 | 390 | 452 | 523 | 234 | 257 | 287 | 397 | 441 | 498 | 382 | 417 | 478 |
| F | Hip width | 315 | 354 | 403 | 330 | 371 | 442 | 175 | 192 | 209 | 283 | 319 | 356 | 290 | 327 | 364 |
| G | Vertical reach | 2065 | 2231 | 2398 | 1898 | 2205 | 2051 | 1094 | 1211 | 1328 | 1854 | 2108 | 2279 | 1854 | 1954 | 1949 |
| H | Forward reach | 760 | 820 | 879 | 671 | 738 | 804 | 389 | 450 | 505 | 707 | 842 | 860 | 626 | 695 | 764 |
| I | Sitting height | 821 | 920 | 979 | 800 | 855 | 870 | 532 | 580 | 587 | 801 | 898 | 972 | 780 | 834 | 863 |
| J | Eye level (seated) | 706 | 805 | 863 | 689 | 743 | 758 | 435 | 482 | 490 | 723 | 821 | 858 | N/A | N/A | N/A |
| K | Elbow height (seated) | 206 | 241 | 276 | 197 | 230 | 264 | 122 | 138 | 150 | 185 | 236 | 248 | 145 | 230 | 237 |
| L | Thigh clearance | 129 | 162 | 207 | 139 | 164 | 209 | N/A | N/A | N/A | N/A | N/A | N/A | N/A | N/A | N/A |
| M | Popliteal height | 410 | 455 | 499 | 370 | 412 | 455 | 227 | 261 | 295 | 370 | 448 | 488 | 370 | 409 | 448 |
| N | Buttock-front knee length | 567 | 619 | 677 | 541 | 592 | 655 | 303 | 339 | 379 | N/A | N/A | N/A | N/A | N/A | N/A |
| O | Buttock-popliteal length | 456 | 503 | 556 | 438 | 484 | 540 | 238 | 274 | 313 | N/A | N/A | N/A | N/A | N/A | N/A |
| P | Sitting reach | 1220 | 1305 | 1390 | 1100 | 1190 | 1280 | 694 | 764 | 818 | 1114 | 1074 | 1343 | 1032 | 1145 | 1257 |

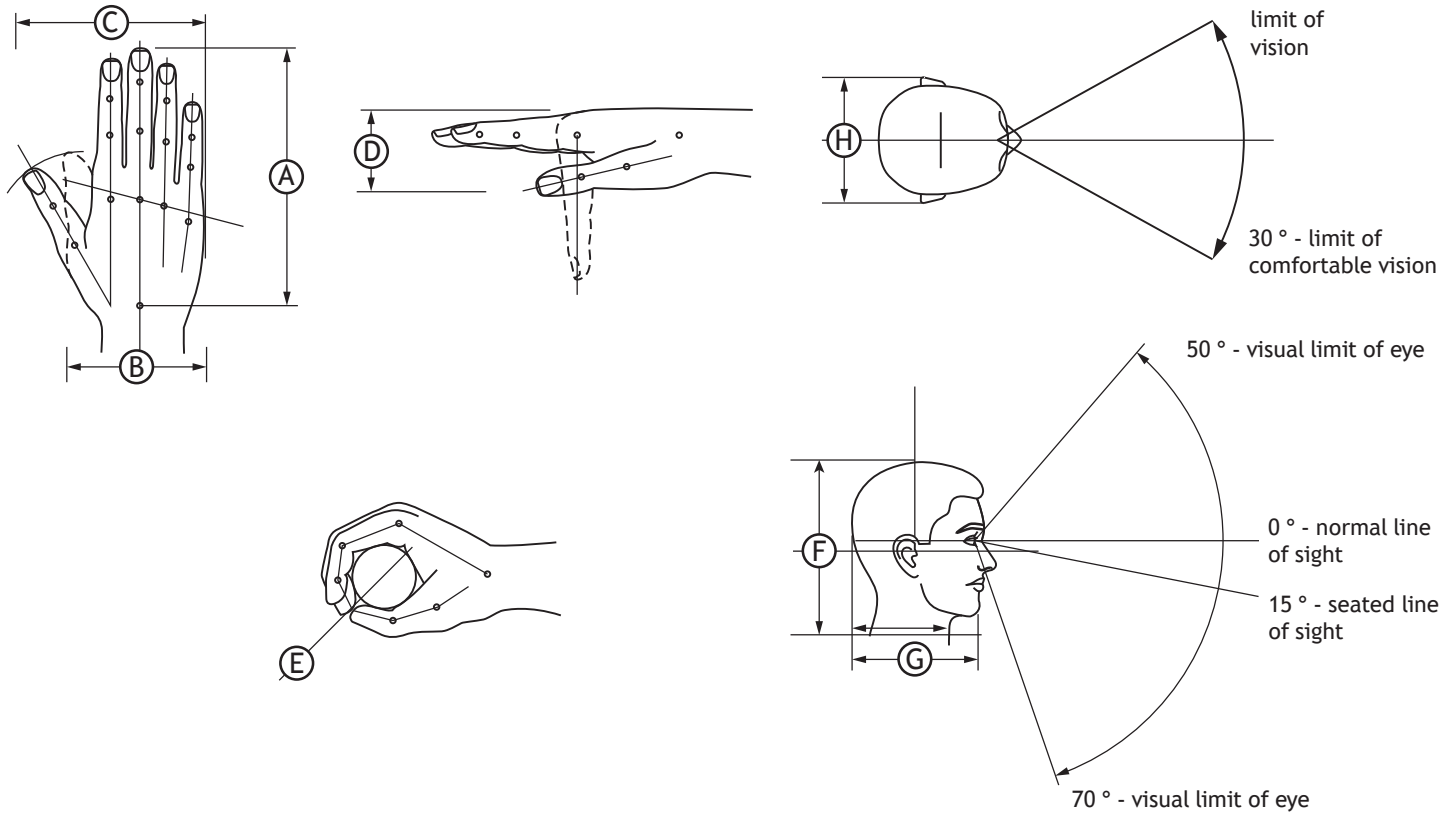

| Hand and head | | Adult male | | | Adult female | | | 4-year-old child | | | 16-year-old boy | | | 16-year-old girl | | |
|---------------|----------------------------|-----------------|------------------|------------------|-----------------|------------------|------------------|------------------|------------------|------------------|-----------------|------------------|------------------|------------------|------------------|------------------|
| | | Percentile | | | Percentile | | | Percentile | | | Percentile | | | Percentile | | |
| | | 5 th | 50 th | 95 th | 5 th | 50 th | 95 th | 5 th | 50 th | 95 th | 5 th | 50 th | 95 th | 5 th | 50 th | 95 th |
| A | Hand length | 170 | 190 | 210 | 160 | 175 | 190 | 106 | 116 | 127 | N/A | N/A | N/A | N/A | N/A | N/A |
| B | Hand breadth | 80 | 90 | 100 | 70 | 80 | 90 | 49 | 55 | 61 | N/A | N/A | N/A | N/A | N/A | N/A |
| C | Hand span | 97 | 107 | 116 | 83 | 92 | 101 | 58 | 66 | 73 | N/A | N/A | N/A | N/A | N/A | N/A |
| D | Hand thickness | 26 | 30 | 34 | 22 | 26 | 30 | 15 | 18 | 21 | N/A | N/A | N/A | N/A | N/A | N/A |
| E | Grip diameter INDEX finger | 35 | 47 | 55 | 33 | 38 | 44 | 62 | 75 | 87 | N/A | N/A | N/A | N/A | N/A | N/A |
| F | Head height | 201 | 217 | 232 | 188 | 201 | 214 | 165 | 181 | 198 | 201 | 219 | 237 | 191 | 207 | 223 |
| G | Head length | 185 | 198 | 210 | 172 | 184 | 196 | 164 | 176 | 188 | 170 | 182 | 193 | 174 | 187 | 200 |
| H | Head breadth | 135 | 144 | 153 | 122 | 131 | 141 | 100 | 109 | 117 | N/A | N/A | N/A | N/A | N/A | N/A |

| Wheelchair | | | |
|------------|-----------------|-------|-------|
| | | Adult | Child |
| A | Height | 914 | 914 |
| B | Length | 1220 | 890 |
| C | Breadth | 760 | 670 |
| D | Seat height | 495 | 360 |
| E | Arm rest height | 737 | N/A |

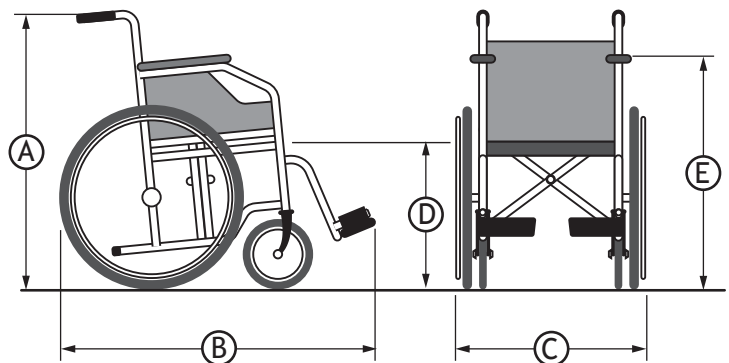

Production costs

Manufacturing processes

The information in the following tables provides estimated costs for the commercial production of component parts. Assumptions on volume of production and economies of scale have been made to allow for comparisons between each process.

Costs are for production only and do not include cost of materials, secondary processes or transportation.

- Small parts are less than or equal to 50 mm x 50 mm x 50 mm
- Medium parts are less than or equal to 150 mm x 150 mm x 150 mm
- Large parts are less than or equal to 300 mm x 300 mm x 300 mm

| | Simple | | | Medium | | | Complex | | |
|-----------------------------|---|--------|--------|--|--------|--------|---|--------|--------|
| | <ul style="list-style-type: none"> • Simple solid form or basic shell structure • Little surface detail or texture • No ribs, webs or bosses • Uniform wall thickness | | | <ul style="list-style-type: none"> • Complex solid form or shell structure • Surface detail and texture • Few manufacturing features: ribs, webs and bosses | | | <ul style="list-style-type: none"> • Highly complex shell structures • High levels of surface detail • Several manufacturing features: ribs, webs and bosses • Integrated assembly features | | |
| | small | medium | large | small | medium | large | small | medium | large |
| Injection moulding | £1.85 | £5.00 | £16.00 | £2.25 | £6.60 | £22.50 | £3.75 | £10.00 | £33.30 |
| Die casting | £1.85 | £5.00 | £16.00 | £2.20 | £5.80 | £19.60 | £3.25 | £8.30 | £28.30 |
| Compression moulding | £0.90 | £2.50 | £8.30 | £1.10 | £2.90 | £9.80 | £1.60 | £4.20 | £14.20 |
| Sand casting | £1.25 | £2.00 | £5.60 | £1.90 | £5.00 | £16.60 | | | |

| | Simple | | | Medium | | | Complex | | |
|----------------------------|--|--------|-------|---|--------|-------|---|--------|--------|
| | <ul style="list-style-type: none"> • Simple geometric forms • Little surface detail or texture • Uniform wall thickness | | | <ul style="list-style-type: none"> • Complex geometric forms • Good level of surface detail | | | <ul style="list-style-type: none"> • Highly complex forms • High levels of surface detail | | |
| | small | medium | large | small | medium | large | small | medium | large |
| Rotational moulding | £0.30 | £0.85 | £2.80 | £0.90 | £2.50 | £8.30 | £1.60 | £4.20 | £14.00 |
| Vacuum forming | £0.30 | £0.85 | £2.80 | £0.65 | £1.60 | £5.60 | £1.25 | £3.30 | £11.25 |

| | Simple | | | Medium | | | Complex | | |
|----------------------|---|--------|-------|---|--------|--------|---|--------|--------|
| | <ul style="list-style-type: none"> • Simple line bends • Thin sheet | | | <ul style="list-style-type: none"> • Complex line bends • Simple geometric forms • Large radii corners | | | <ul style="list-style-type: none"> • Highly complex line bends • Complex geometric forms • Small radii corners • Deep drawing | | |
| | small | medium | large | small | medium | large | small | medium | large |
| Press forming | £0.62 | £1.60 | £5.60 | £1.25 | £3.30 | £11.25 | £1.87 | £5.00 | £16.60 |

The information in the following table provides estimated costs for extrusion.

Costs are for production only and do not include cost of materials, secondary processes or transportation.

- Small parts are less than or equal to 10 mm x 10 mm
- Medium parts are less than or equal to 50 mm x 50 mm
- Large parts are less than or equal to 100 mm x 100 mm
(price per linear metre)

| | Simple | | | Medium | | | Complex | | |
|------------------|---|--------|-------|---|--------|-------|--|--------|-------|
| | <ul style="list-style-type: none"> • Simple geometric forms • Open profile L H T sections | | | <ul style="list-style-type: none"> • Complex geometric forms • Closed profile | | | <ul style="list-style-type: none"> • Highly complex geometric forms | | |
| | small | medium | large | small | medium | large | small | medium | large |
| Extrusion | £2·60 | £3·00 | £3·50 | £3·00 | £3·50 | £4·50 | £3·40 | £4·00 | £5·00 |

Fabrication costs

| Machining | | | |
|-------------------|---------------------------|---------------------------|---------------------------|
| | Wood | Metal | Plastic |
| Lathe work | £0·15 per feature/process | £0·20 per feature/process | £0·20 per feature/process |
| Milling | | £0·20 per feature/process | £0·20 per feature/process |
| Drilling | £0·25 per hole | £0·40 per hole | £0·25 per hole |

| Cutting and forming | | | |
|----------------------------|----------------|----------------|----------------|
| | Wood | Metal | Plastic |
| Bending | £0·50 per bend | £0·25 per bend | £0·20 per bend |
| Cutting | £0·20 per cut | £0·20 per cut | £0·20 per cut |

| Finishing (price per 1000 mm²) | | | |
|--|-------|-------|---------|
| | Wood | Metal | Plastic |
| Chrome plating | | £0·15 | £0·15 |
| Galvanising | | £0·15 | |
| Dip coating | | £0·15 | |
| Painting | £0·10 | £0·10 | £0·10 |
| Powder coating | | £0·15 | |
| Polishing | | £0·05 | £0·05 |

Assembly costs

| | Wood | Metal | Plastic |
|--|-----------------|-----------------|-----------------|
| Assembling using snap fits | | £0·05 per part | £0·05 per part |
| Assembling using screws, nuts and bolts | £0·15 per part | £0·15 per part | £0·15 per part |
| Assembling using glue | £0·10 per part | £0·10 per part | £0·10 per part |
| Welding | | £0·50 per join | |
| Riveting | £0·10 per rivet | £0·10 per rivet | £0·10 per rivet |

Stock material sizes and costs (*all sizes given in mm)









Dressed timber, man-made boards and dowelling

| Dressed timber (price per linear metre) | | | | | |
|---|-------|--------|--------|----------|--------|
| Size | Pine | Ash | Beech | Mahogany | Oak |
| 25 × 25 | £0.50 | £1.93 | £1.52 | £2.05 | £2.37 |
| 50 × 25 | £0.93 | £4.80 | £2.75 | £3.68 | £4.27 |
| 50 × 50 | £1.75 | £8.67 | £5.71 | £7.38 | £10.49 |
| 75 × 25 | £1.30 | £5.02 | £3.98 | £5.34 | £6.18 |
| 75 × 50 | £2.85 | £12.55 | £8.26 | £10.69 | £15.17 |
| 75 × 75 | £3.25 | £16.38 | £11.97 | £17.08 | £44.88 |
| 100 × 25 | £1.86 | £6.56 | £5.22 | £7.00 | £12.08 |
| 100 × 50 | £3.71 | £16.42 | £10.82 | £13.20 | £19.85 |
| 100 × 100 | £6.80 | | | £21.08 | £54.80 |
| 150 × 25 | £2.60 | £9.65 | £7.68 | £10.29 | £18.12 |
| 150 × 50 | £5.46 | £24.15 | £15.91 | £20.58 | £30.30 |
| 175 × 25 | £3.22 | £11.20 | £8.91 | £11.94 | £14.27 |
| 175 × 50 | £6.51 | £28.02 | £18.46 | £23.88 | £35.16 |
| 200 × 25 | £3.68 | £12.38 | £10.14 | £13.58 | £20.68 |
| 225 × 25 | £4.14 | | £11.32 | £15.25 | £23.08 |

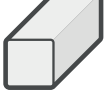
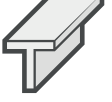
| Man-made boards (price per 1220 mm × 2440 mm sheet) | | | | | |
|---|--------|-----------|---------|-----------|-----------|
| Size | MDF | Flexi ply | Plywood | Hardboard | Chipboard |
| 3 | | £29.98 | | £5.95 | |
| 5 | | £34.98 | | | |
| 6 | £14.49 | | £15.86 | | |
| 8 | | £39.98 | | | |
| 9 | £21.74 | | £19.04 | | |
| 12 | £23.00 | | £26.99 | | £11.48 |
| 15 | | | | | |
| 18 | £26.63 | | £38.90 | | £17.36 |
| 25 | £36.99 | | | | |



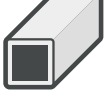



| Dowelling (price per linear metre) | | | | | |
|------------------------------------|--------|--------|----------|--------|-------|
| Size | Ash | Beech | Mahogany | Oak | Pine |
| Ø 6 | £0.94 | £0.94 | £1.62 | £0.90 | |
| Ø 9 | £1.43 | £1.45 | £2.22 | £1.51 | |
| Ø 12 | | | £2.94 | £2.34 | £2.08 |
| Ø 15 | £2.94 | £2.22 | £3.59 | £3.13 | £2.88 |
| Ø 18 | £3.16 | £2.65 | £4.25 | £3.48 | £3.06 |
| Ø 25 | £4.19 | £3.46 | £5.82 | £4.14 | £3.96 |
| Ø 35 | £8.16 | £7.51 | £10.26 | £8.10 | £6.66 |
| Ø 45 | £15.32 | £14.64 | £14.04 | £16.04 | |

Metal sections and sheets

| Metal sections (price per linear metre) | | | | | |
|--|---------------|------------|-----------|-----------------|---------|
| | Size | Mild steel | Aluminium | Stainless steel | Brass |
| Round bar  | Ø 10 | £2.15 | £4.40 | £9.10 | £17.10 |
| | Ø 20 | £7.03 | £9.23 | £18.79 | £30.66 |
| | Ø 30 | £14.67 | £17.06 | £42.23 | £84.40 |
| | Ø 40 | £26.09 | £28.84 | £75.02 | £169.70 |
| | Ø 50 | £40.75 | £43.67 | £117.17 | £225.90 |
| Flat bar  | 3 × 20 | £2.96 | £1.84 | £7.72 | £17.10 |
| | 3 × 30 | £3.54 | £3.37 | £9.72 | £23.28 |
| | 5 × 40 | £7.13 | £7.54 | £15.53 | £37.93 |
| | 5 × 50 | £8.90 | £9.10 | £13.87 | £39.97 |
| Square bar  | 10 × 10 | £3.36 | £4.21 | £12.35 | £16.73 |
| | 20 × 20 | £13.37 | £11.75 | £33.17 | £44.65 |
| | 30 × 30 | £30.10 | £21.71 | £57.32 | £118.40 |
| | 40 × 40 | £53.66 | £31.27 | | £137.40 |
| | 50 × 50 | | £55.62 | | £275.35 |
| T section  | 20 × 20 × 1.6 | | £4.84 | | |
| | 25 × 25 × 3 | | £5.30 | £29.18 | £54.63 |
| | 40 × 40 × 5 | | £9.14 | | £84.43 |
| | 50 × 50 × 6 | £36.99 | £13.03 | | |
| U Section  | 25 × 25 × 3 | £11.16 | £7.19 | £29.31 | £69.20 |
| | 40 × 20 × 3 | | £9.95 | £42.05 | |
| | 50 × 25 × 3 | | £12.03 | £47.37 | |
| | 70 × 40 × 5 | £33.49 | £24.00 | | |
| | 100 × 50 × 6 | £18.14 | £44.00 | £134.58 | |
| I section  | 76 × 35 | £33.49 | | | |
| | 127 × 76 | £32.10 | | | |
| | 203 × 102 | £57.43 | | | |
| | 254 × 254 | £76.55 | | | |
| Angle bar  | 25 × 25 × 3 | £4.40 | £4.87 | £14.97 | £27.25 |
| | 30 × 30 × 3 | £5.95 | £6.23 | £20.36 | £49.98 |
| | 40 × 40 × 5 | £7.34 | £11.00 | £27.77 | £59.66 |
| | 50 × 50 × 5 | £14.96 | £22.16 | £52.53 | |
| Square section  | 15 × 15 × 2 | £2.84 | £5.95 | £14.89 | £27.04 |
| | 20 × 20 × 2 | £2.96 | £10.63 | £22.21 | £35.40 |
| | 30 × 30 × 3 | £6.62 | £11.99 | £17.18 | £62.76 |
| | 50 × 50 × 3 | £11.61 | £20.00 | £37.52 | £95.15 |
| Round tube  | Ø 15 × 1.2 | £1.27 | £2.39 | £8.63 | £23.10 |
| | Ø 20 × 2 | £1.92 | £3.44 | £15.22 | £28.02 |
| | Ø 30 × 2 | £3.42 | £5.04 | £14.10 | £45.07 |
| | Ø 40 × 3 | £6.98 | £16.08 | £28.61 | £58.06 |
| Box section  | 50 × 50 × 3 | £9.76 | £15.74 | £22.33 | £72.41 |
| | 25 × 10 × 2 | | £5.04 | | |
| | 40 × 20 × 2 | | £7.29 | £18.76 | £52.65 |
| | 50 × 25 × 2 | | £14.65 | £22.60 | £69.60 |
| | 50 × 100 × 3 | | £34.79 | | |

| Sheet metal (price per 1000 mm × 1000 mm sheet) | | | | | | |
|---|-------------------------------------|------------|-----------|-----------------|---------|---------|
| | Size | Mild steel | Aluminium | Stainless steel | Brass | Copper |
| Sheets | 1 mm thick | £17.17 | £16.67 | £75.05 | £292.89 | |
| | 2 mm thick | £40.88 | £38.73 | £160.39 | £238.40 | £297.00 |
| | 3 mm thick | £51.10 | £52.96 | £240.55 | £361.60 | £440.00 |
| | 4 mm thick | | £94.63 | | £598.46 | |
| | 6 mm thick | £84.05 | £127.60 | | | |
| Perforated sheet | 6 mm hole, 8 mm pitch, 1 mm thick | £41.57 | | | | |
| | 10 mm hole, 15 mm pitch, 3 mm thick | £75.62 | | | | |
| Tred plate | 3 mm thick | £70.42 | £66.06 | | | |

Plastic sections, granules and sheets

| Plastic sections (price per linear metre) | | | | | | | | |
|---|--|---------|---------|---------------|-------------|-----------|-------|--------|
| | Size | ABS | Acrylic | Polypropylene | Polystyrene | Polythene | PVC | Nylon |
| Round bar  | Ø 10 | | £3.78 | £1.43 | | £0.73 | | £1.74 |
| | Ø 20 | | £12.68 | £5.32 | | £1.25 | | £6.62 |
| | Ø 30 | | £28.00 | £10.62 | | £4.00 | | £10.62 |
| | Ø 40 | | £50.75 | £18.98 | | £6.63 | | £25.52 |
| | Ø 50 | | £93.35 | £27.36 | | £26.53 | | £32.51 |
| | Square bar  | 10 × 10 | | £4.18 | £1.57 | | | |
| 20 × 20 | | | £13.98 | £5.85 | | | | £7.24 |
| 30 × 30 | | | £30.80 | £12.24 | | | | £11.68 |
| 40 × 40 | | | £55.75 | £20.98 | | | | £28.02 |
| 50 × 50 | | | | | | | | £35.75 |
| Square tube  | 10 × 10 | | £2.20 | | | | £0.95 | |
| | 20 × 20 | | £5.80 | | | | £1.07 | |
| | 30 × 30 | | £7.45 | | | | £1.32 | |
| | 40 × 40 | | £8.61 | | | | £1.68 | |
| | 50 × 50 | | £11.98 | | | | £2.07 | |
| Round tube  | Ø 10 | £0.69 | £2.00 | | | | £0.42 | |
| | Ø 20 | £1.02 | £5.20 | | | | £0.76 | |
| | Ø 30 | £1.69 | £6.95 | | | | £2.07 | |
| | Ø 40 | £2.36 | £8.00 | | | | £3.00 | |
| | Ø 50 | £3.03 | £11.02 | | | | £4.73 | |
| Angle  | 25 × 25 × 2 | | | | | | £1.19 | |
| | 30 × 30 × 2 | | | | | | £1.59 | |
| | 40 × 40 × 2 | | | | | | £2.23 | |
| | 50 × 50 × 2 | | | | | | £3.02 | |
| U channel  | 25 × 25 × 2 | | | | | | £1.50 | |
| | 20 × 20 × 2 | | | | | | £1.29 | |
| | 15 × 15 × 2 | | | | | | £1.12 | |
| | 10 × 10 × 2 | | | | | | £0.84 | |

| Plastic granules (price per kg) | | | | | | | |
|---------------------------------|--------|---------|---------------|-------------|-----------|--------|--------|
| | ABS | Acrylic | Polypropylene | Polystyrene | Polythene | PVC | Nylon |
| Granules | £21.00 | £24.00 | £14.00 | £18.00 | £14.00 | £12.00 | £28.00 |

| Plastic sheet materials (price per 1000 mm × 1000 mm sheet) | | | | | | |
|---|-------|---------|---------------|-------------|---------|---------|
| | Size | Acrylic | Polypropylene | Polystyrene | PVC | Nylon |
| Sheets | 1 mm | | £11.56 | £12.60 | £11.52 | £16.98 |
| | 4 mm | £40.60 | £33.45 | £34.16 | £33.99 | £68.09 |
| | 8 mm | £76.96 | £66.91 | | £67.99 | £94.74 |
| | 12 mm | £121.80 | £100.37 | | £101.97 | £207.10 |

Fixings

| Threaded bar, nuts, bolts and washers | | | | | |
|---|---------|-------|-------|-------|-------|
| | Length | M6 | M8 | M10 | M12 |
| Zinc plated threaded bar | 1000 mm | £1.24 | £1.73 | £2.48 | £3.71 |
| Zinc plated nut (price per pack of 10) | | £1.00 | £1.90 | £2.80 | £3.80 |
| Zinc plated washer (price per pack of 10) | | £0.80 | £1.00 | £1.30 | £1.50 |
| Nut, bolt and washer (price per pack of 10) | 20 mm | £1.16 | £1.29 | £1.49 | £1.61 |
| | 30 mm | £1.47 | £1.77 | £1.98 | £2.10 |
| | 40 mm | £2.79 | £2.94 | £3.21 | £3.39 |
| | 50 mm | | | | |

| Screws (price per pack of 10) | | | | | |
|-------------------------------|--------|----------|--------|--------|--------|
| | Length | Ø 3.5 mm | Ø 4 mm | Ø 5 mm | Ø 6 mm |
| CSK wood | 20 mm | £0.20 | £0.22 | | |
| | 30 mm | £0.22 | £0.24 | | |
| | 40 mm | £0.22 | £0.28 | | |
| | 50 mm | £0.30 | £0.35 | £0.30 | |
| | 60 mm | | £0.40 | £0.60 | |
| | 70 mm | | £0.55 | £0.70 | |
| | 80 mm | | | £0.75 | £1.29 |
| | 100 mm | | | £1.00 | £1.60 |
| Stainless steel self-tapping | 12 mm | £0.40 | | | |
| | 25 mm | £0.50 | £0.80 | £1.00 | |

| Pop rivets (price per pack of 10) | | | |
|-----------------------------------|----------|--------|----------|
| Length | Ø 3.2 mm | Ø 4 mm | Ø 4.8 mm |
| 8 mm | £0.16 | £0.20 | |
| 12 mm | | £0.34 | £0.34 |
| 16 mm | | | £0.60 |
| 25 mm | | | £0.82 |

Published: September 2019

Change since last published:

Page 4: amends to Standing and seated table

16-year-old-girl - rows B, C, G, I, K and M

16-year-old-boy - row D

4-year-old-child - row D

Adult female - rows D and H

Adult male - row H

Page 7: prices halved on the 'Machining' and 'Cutting and forming' tables

'Finishing' table heading changed from 100m² to 1000mm²

'Assembly costs' table - prices changed.