



2013 Graphic Communication

Intermediate 1

Finalised Marking Instructions

© Scottish Qualifications Authority 2013

The information in this publication may be reproduced to support SQA qualifications only on a non-commercial basis. If it is to be used for any other purposes written permission must be obtained from SQA's NQ Assessment team.

Where the publication includes materials from sources other than SQA (secondary copyright), this material should only be reproduced for the purposes of examination or assessment. If it needs to be reproduced for any other purpose it is the centre's responsibility to obtain the necessary copyright clearance. SQA's NQ Assessment team may be able to direct you to the secondary sources.

These Marking Instructions have been prepared by Examination Teams for use by SQA Appointed Markers when marking External Course Assessments. This publication must not be reproduced for commercial or trade purposes.

Part One: General Marking Principles for Graphic Communications Intermediate 1

This information is provided to help you understand the general principles you must apply when marking candidate responses to questions in this Paper. These principles must be read in conjunction with the specific Marking Instructions for each question.

- (a)** Marks for each candidate response must always be assigned in line with these general marking principles and the specific Marking Instructions for the relevant question. If a specific candidate response does not seem to be covered by either the principles or detailed Marking Instructions, and you are uncertain how to assess it, you must seek guidance from your Team Leader/Principal Assessor.
- (b)** Marking should always be positive ie, marks should be awarded for what is correct and not deducted for errors or omissions.

GENERAL MARKING ADVICE: Graphic Communications Intermediate 1

The marking schemes are written to assist in determining the “minimal acceptable answer” rather than listing every possible correct and incorrect answer. The following notes are offered to support Markers in making judgements on candidates’ evidence, and apply to marking both end of unit assessments and course assessments.

Part Two: Marking Instructions for each Question

Question		Expected Answer/s	Max Mark	Additional Guidance
1	a	Pine	1	
	b	220mm	1	
	c	4	1	
	d	8mm	1	
	e	111631	1	
			(5)	

Question			Expected Answer/s	Max Mark	Additional Guidance
2	a	i	Yellow	1	
		ii	Red	1	
	b		Orange	1	
	c		Equal amounts of two primary colours	1	
				(4)	

Question			Expected Answer/s	Max Mark	Additional Guidance
3	a		Mirror	1	
	b		Zoom, Scale	1	
	c		Rotate	1	
	d		Hatch, Fill	1	
				(4)	

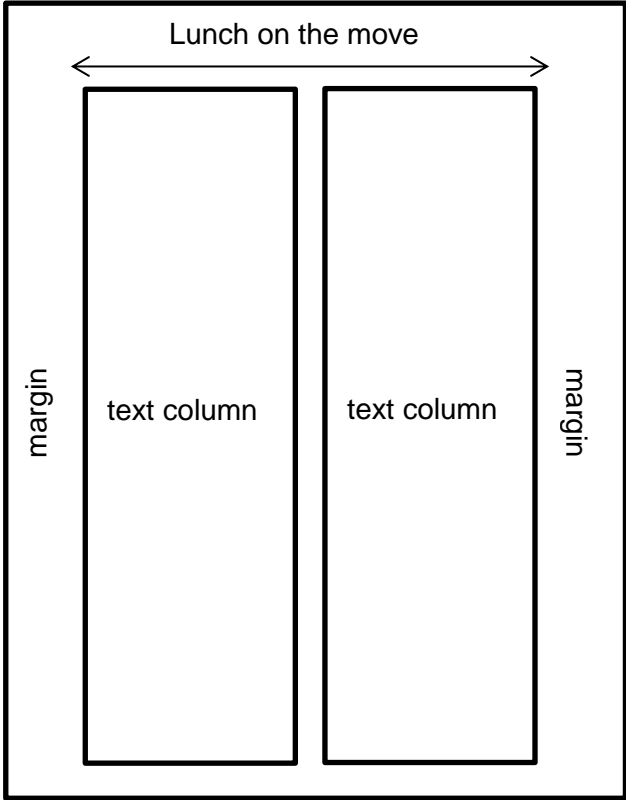

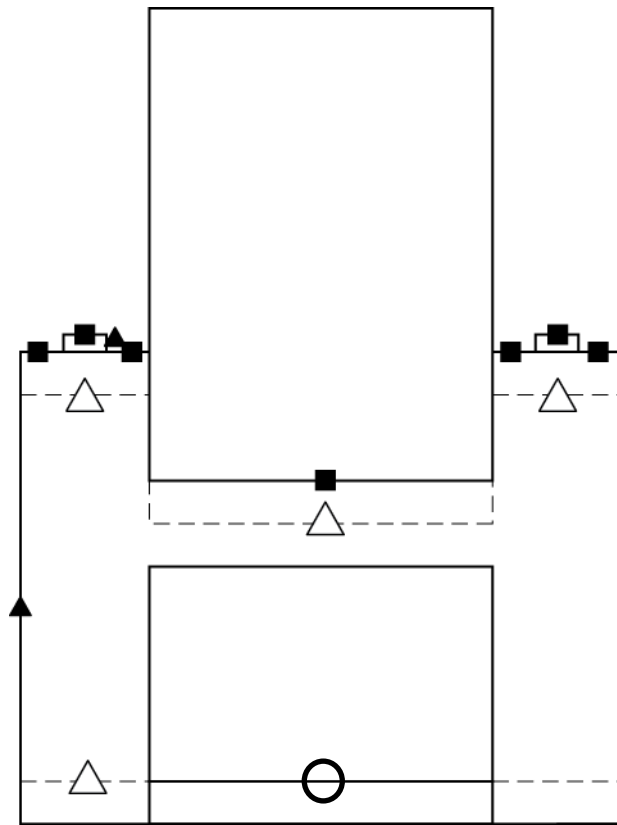

Question	Expected Answer/s	Max Mark	Additional Guidance
4	 <p>The diagram shows a rectangular page layout. At the top, the text "Lunch on the move" is centered. Below it, a horizontal double-headed arrow spans the width of the two columns. The page is divided into two vertical columns, each labeled "text column". On the left and right sides of the page, there are vertical labels "margin".</p>		
a	Portrait page	1	
b	Header	1	
c	Margins	1	
d	2 columns	1	
		(4)	

Notes for drawing questions:

- Tolerances for all drawings +/- 1mm
- When marking drawings, all markers must operate the “follow-on rule” and ensure that candidates are **not** penalised twice.
- Marks should be entered in the appropriate place and no other comments added to the candidates scripts.



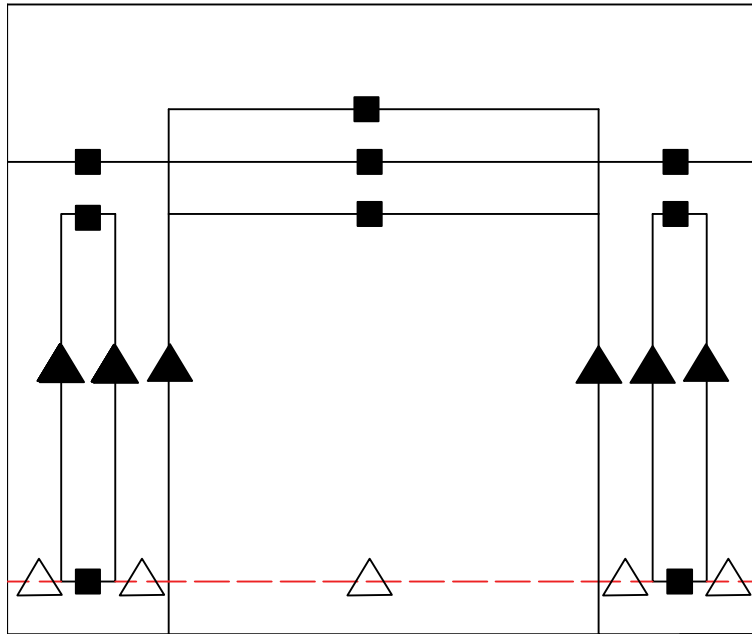

ELEVATION

Question		Expected Answer/s	Max Mark	Additional Guidance
5	a	Correct projection from end elevation	1	
	b	Overall length and height	1	
	c	2 heights marked 	1	
	d	7 widths marked  5/7 widths for 1 mark	1	
	e	1 horizontal line marked 	1	
	f	5 hidden lines marked  5 for 2 marks 3/4 for 1 marks	2	



PLAN

Question		Expected Answer/s	Max Mark	Additional Guidance
5	g	Overall length and width	1	
	h	6 vertical lines marked  5/6 vertical lines for 1 mark	1	
	i	9 horizontal lines marked  8/9 horizontal lines for 1 mark	1	
	j	5 hidden lines marked  5 hidden lines for 2 marks 3/4 hidden lines for 1 mark	2	
			(12)	

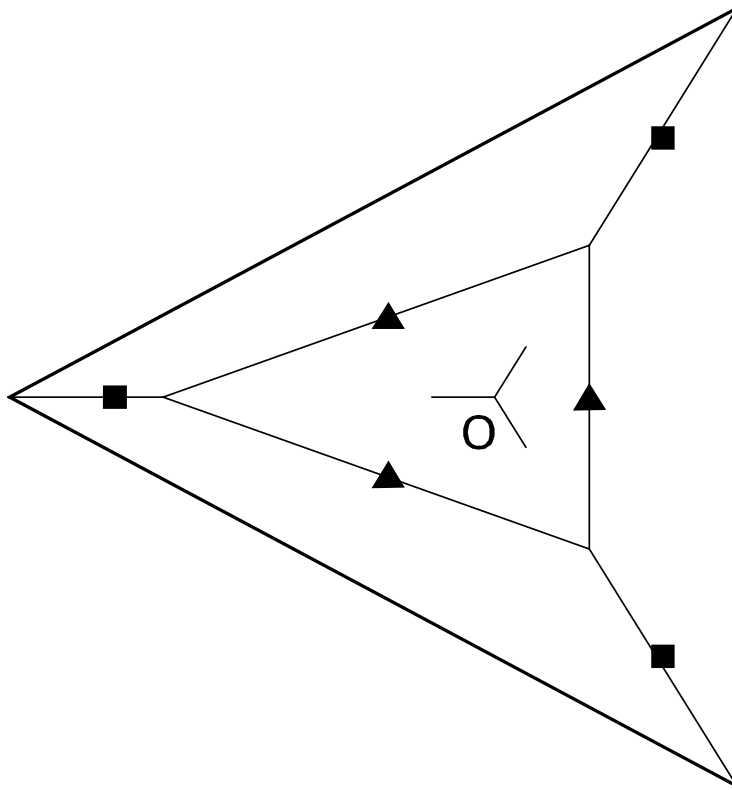

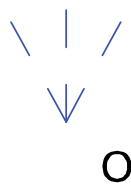
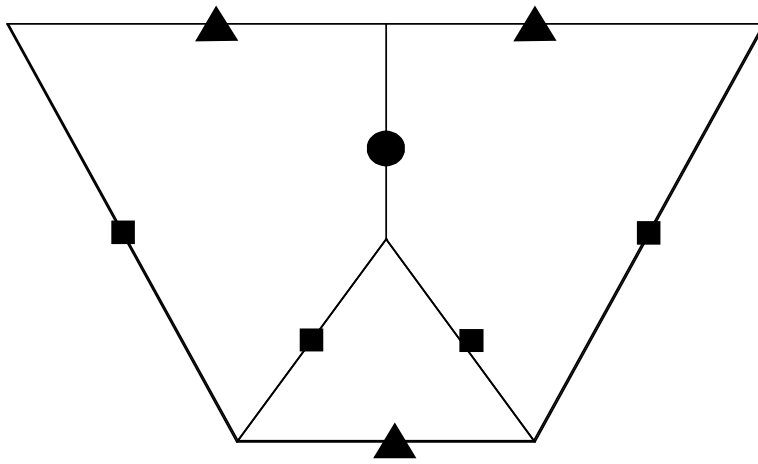

PLAN

Question		Expected Answer/s	Max Mark	Additional Guidance
6	a	3 diagonal construction lines for pyramid	1	
	b	Projected from elevation correctly	1	
	c	3 lines marked ■	1	
	d	3 lines marked ▲	1	



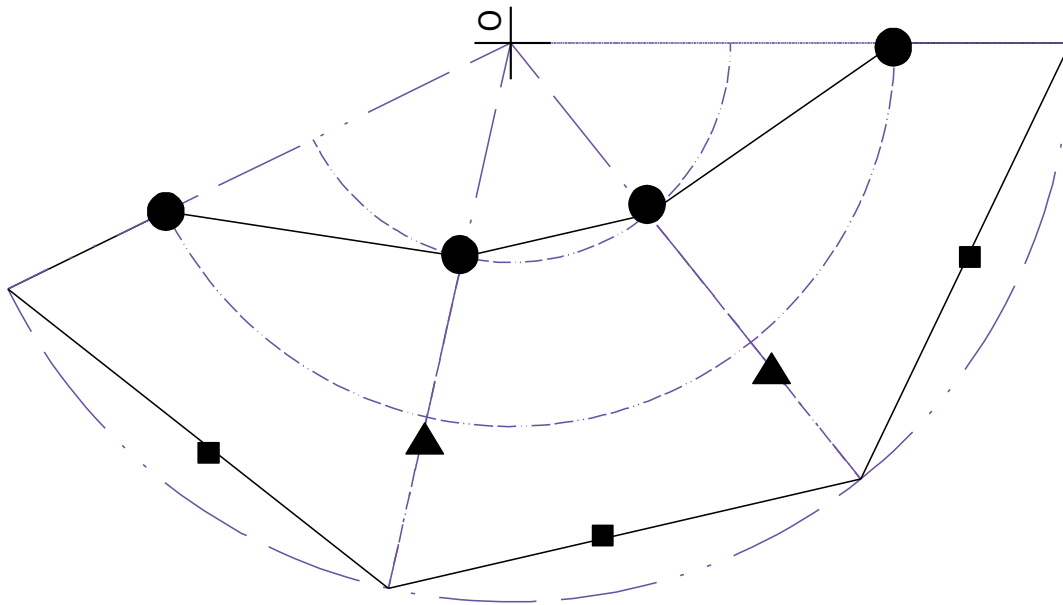

END ELEVATION

Question		Expected Answer/s	Max Mark	Additional Guidance
6	e	3 Correct widths marked 	1	
	f	Sloping lines marked  4 for 2 marks 2/3 for 1 mark	2	
	g	1 vertical line marked 	1	





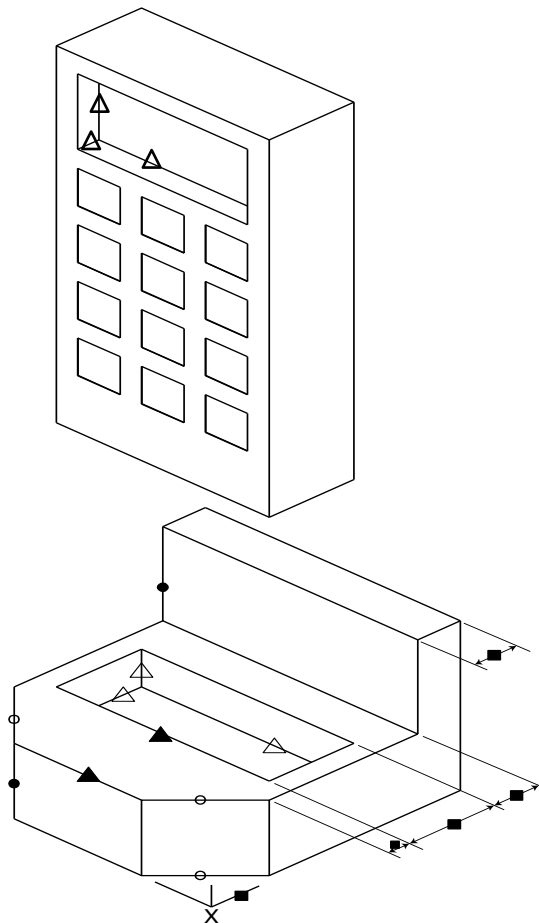

DEVELOPMENT

Question		Expected Answer/s	Max Mark	Additional Guidance
6	h	True length used for arc	1	
	i	3 equal divisions marked 	1	
	j	4 heights marked 	1	
	k	2 fold lines marked 	1	
	l	Correctly outlined	1	
			(13)	



CHARGER

Question		Expected Answer/s	Max Mark	Additional Guidance
7	a	Overall LxBxH	1	
	b	5 widths marked  5 for 2 marks 3/4 for 1 mark	2	
	c	2 heights marked 	1	
	d	2 lengths marked 	1	
	e	3 sloping lines marked 	1	
	f	Depth of recess – 3 lines marked 	1	
	g	Correct position of recess	1	

PHONE

Question			Expected Answer/s	Max Mark	Additional Guidance
7	h		Correct LxBxH	1	

SCREEN



Question			Expected Answer/s	Max Mark	Additional Guidance
7	i		Overall height and width	1	
	j		Depth of recess – 3 lines marked 	1	
	k		Correct position	1	

PHONE BUTTONS

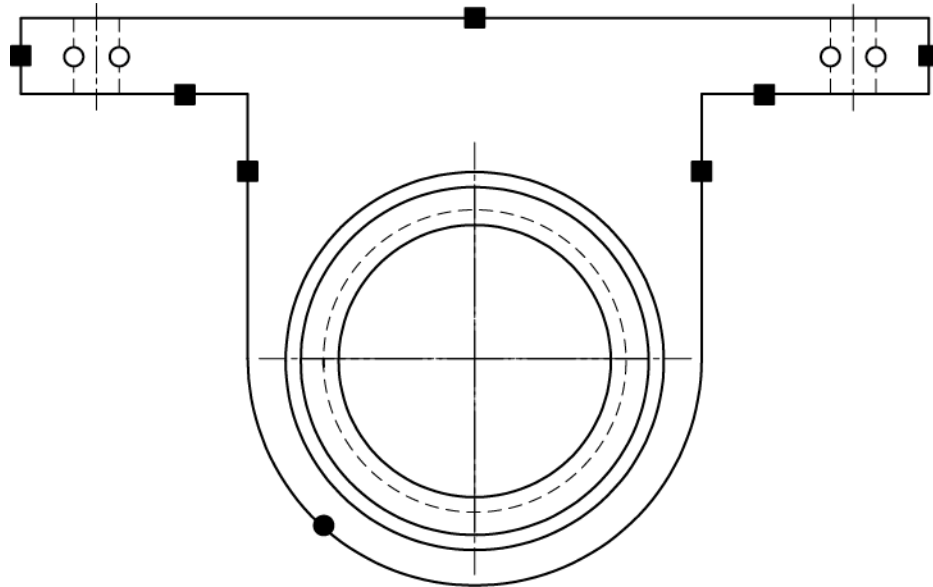
Question			Expected Answer/s	Max Mark	Additional Guidance
7	l		Correct LxH of 1 button	1	
	m		12 buttons positioned	1	
				(14)	



PLAN

Question		Expected Answer/s	Max Mark	Additional Guidance
8	a	7 outline lines marked 	1	
	b	4 hidden lines marked 	1	
	c	1 curve marked 	1	

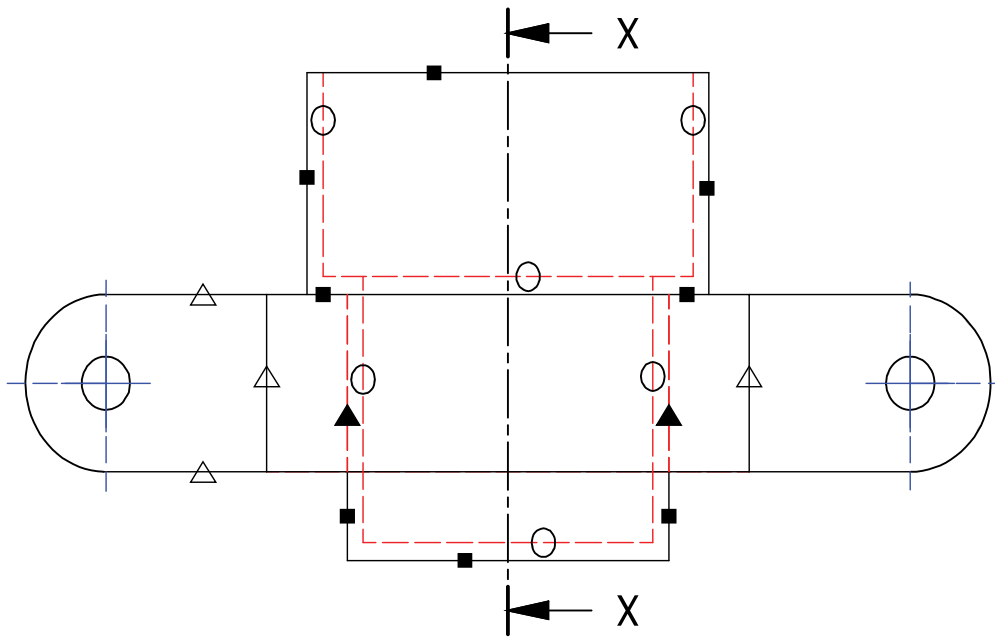

ELEVATION

Question		Expected Answer/s	Max Mark	Additional Guidance
8	d	Correct projection from plan/pre given elevation	1	
	e	Outline of glass – 8 lines marked 	1	
	f	5/6 hidden lines marked 	1	
	g	2 hidden lines marked 	1	
	h	4 lines for cup holder marked 	1	

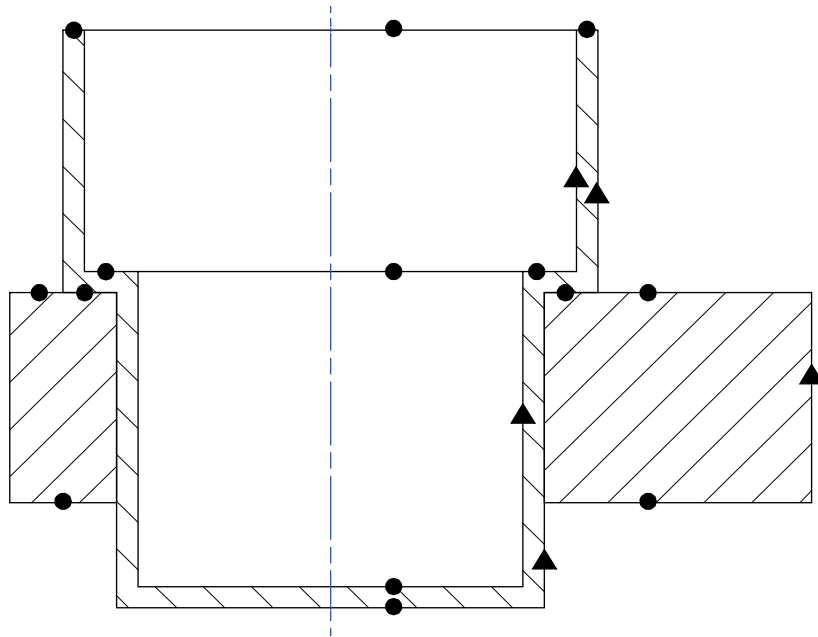

SECTIONAL END ELEVATION

Question		Expected Answer/s	Max Mark	Additional Guidance
8	i	14 widths marked ● 11-14 widths for 2 marks 8-10 widths for 1 mark	2	
	j	5 heights marked ▲ 5 heights for 2 marks 3-4 heights for 1 mark	2	
	k	2 parts hatched correctly	1	
	l	Correct BS and conventions for hatching 45° and differentiated	1	
			(14)	

[END OF MARKING INSTRUCTIONS]