

FOR OFFICIAL USE



National
Qualifications
2019

Mark

X847/75/01

**Mathematics
Paper 1 (Non-calculator)**

FRIDAY, 3 MAY

9:00 AM – 10:15 AM



* X 8 4 7 7 5 0 1 *

Fill in these boxes and read what is printed below.

Full name of centre

Town

Forename(s)

Surname

Number of seat

Date of birth

Day

Month

Year

Scottish candidate number

Total marks — 50

Attempt ALL questions.

You may NOT use a calculator.

To earn full marks you must show your working in your answers.

State the units for your answer where appropriate.

Write your answers clearly in the spaces provided in this booklet. Additional space for answers is provided at the end of this booklet. If you use this space you must clearly identify the question number you are attempting.

Use **blue** or **black** ink.

Before leaving the examination room you must give this booklet to the Invigilator; if you do not, you may lose all the marks for this paper.



* X 8 4 7 7 5 0 1 0 1 *

FORMULAE LIST

The roots of $ax^2 + bx + c = 0$ are $x = \frac{-b \pm \sqrt{(b^2 - 4ac)}}{2a}$

Sine rule $\frac{a}{\sin A} = \frac{b}{\sin B} = \frac{c}{\sin C}$

Cosine rule $a^2 = b^2 + c^2 - 2bc \cos A$ or $\cos A = \frac{b^2 + c^2 - a^2}{2bc}$

Area of a triangle $A = \frac{1}{2}ab \sin C$

Volume of a sphere $V = \frac{4}{3}\pi r^3$

Volume of a cone $V = \frac{1}{3}\pi r^2 h$

Volume of a pyramid $V = \frac{1}{3}Ah$

Standard deviation $s = \sqrt{\frac{\Sigma(x - \bar{x})^2}{n - 1}}$

or $s = \sqrt{\frac{\Sigma x^2 - \frac{(\Sigma x)^2}{n}}{n - 1}}$, where n is the sample size.



* X 8 4 7 7 5 0 1 0 2 *

MARKS

DO NOT
WRITE IN
THIS
MARGIN

Total marks — 50
Attempt ALL questions

1. Given that $f(x) = 5x^3$, evaluate $f(-2)$.

2

2. Evaluate $\frac{3}{8} \times 1\frac{5}{7}$.

Give your answer in its simplest form.

2



* X 8 4 7 7 5 0 1 0 3 *

3. Expand and simplify $(x+5)(2x^2-7x-3)$.

3

4. The diagram below shows a sector of a circle, centre C.

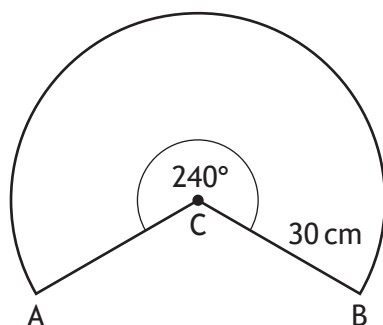

The radius of the circle is 30 centimetres.

Calculate the length of the major arc AB.

Take $\pi = 3.14$.

3



5. The midday temperatures in Grantford were recorded over a nine day period. The temperatures, in °C, were

4 7 4 3 6 10 9 5 3

- (a) Calculate the median and semi-interquartile range for these temperatures. 3

Over the same nine day period the midday temperatures in Endoch were also recorded.

The median temperature was 8 °C, and the semi-interquartile range was 1.5 °C.

- (b) Make two valid comments comparing the midday temperatures of Grantford and Endoch during this period. 2



6. The fuel consumption of a group of cars is recorded.
 The scattergraph shows the relationship between the fuel consumption, F kilometres per litre, and the engine size, E litres, of the cars.

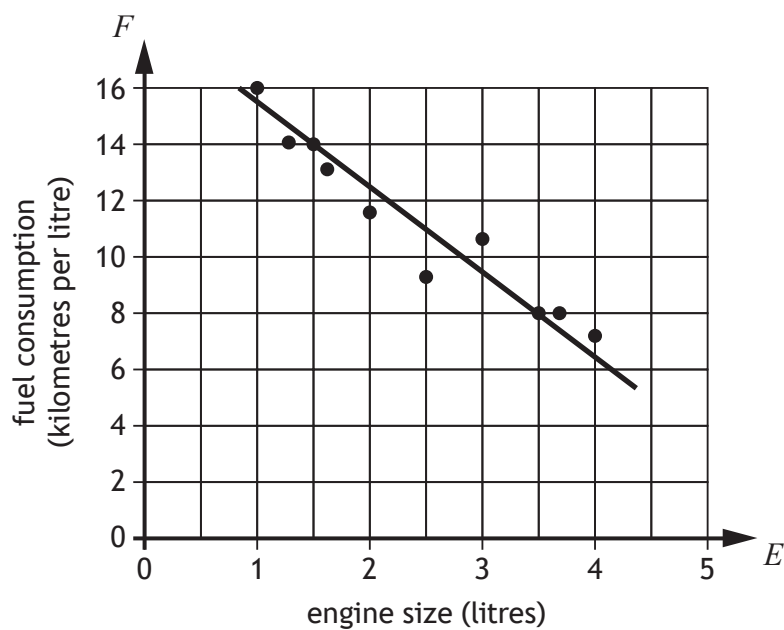

A line of best fit has been drawn.

- (a) Find the equation of the line of best fit in terms of F and E .
 Give the equation in its simplest form.

3



6. (continued)

Amaar's car has an engine size of 1.1 litres.

- (b) Use your equation from part (a) to estimate how many kilometres per litre he should expect to get.

1

7. The area of a trapezium is given by the formula

$$A = \frac{1}{2}h(x + y).$$

Make x the subject of the formula.

3



8. John bought 7 bags of cement and 3 bags of gravel.

The total weight of these bags was 215 kilograms.

- (a) Write down an equation to illustrate this information.

1

Shona bought 5 bags of cement and 4 bags of gravel.

The total weight of her bags was 200 kilograms.

- (b) Write down an equation to illustrate this information.

1

- (c) Calculate the weight of one bag of cement and the weight of one bag of gravel.

4



9. The graph shows a parabola.

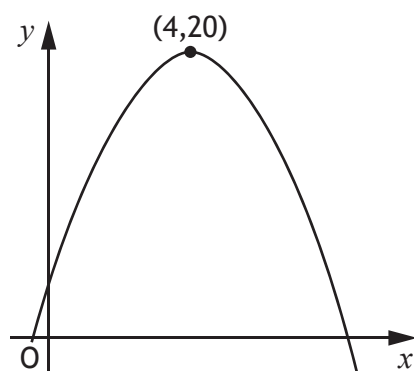

The maximum turning point has coordinates (4,20) as shown in the diagram.

(a) Write down the equation of the axis of symmetry of the graph. 1

The equation of the parabola is of the form $y = b - (x + a)^2$.

(b) State the values of
(i) a 1

(ii) b . 1



10. In triangle PQR, $\vec{PR} = \begin{pmatrix} 6 \\ -4 \end{pmatrix}$ and $\vec{RQ} = \begin{pmatrix} -1 \\ 8 \end{pmatrix}$.

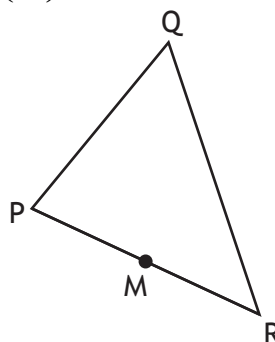

(a) Express \vec{PQ} in component form.

1

M is the midpoint of PR.

(b) Express \vec{MQ} in component form.

2



11. Pam is designing a company logo.
 She starts by drawing a regular pentagon ABCDE.
 The vertices of the pentagon lie on the circumference of a circle with centre O.

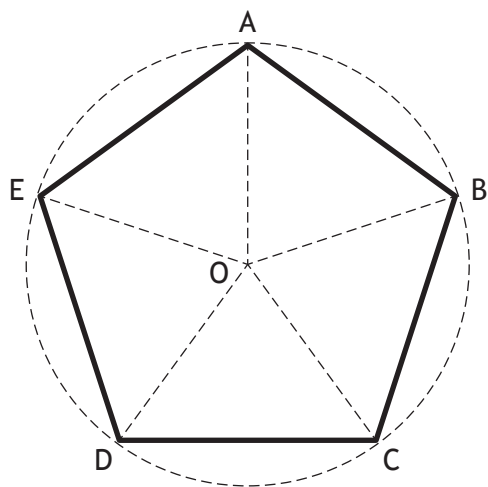

She then adds to the design as shown in the diagram below.

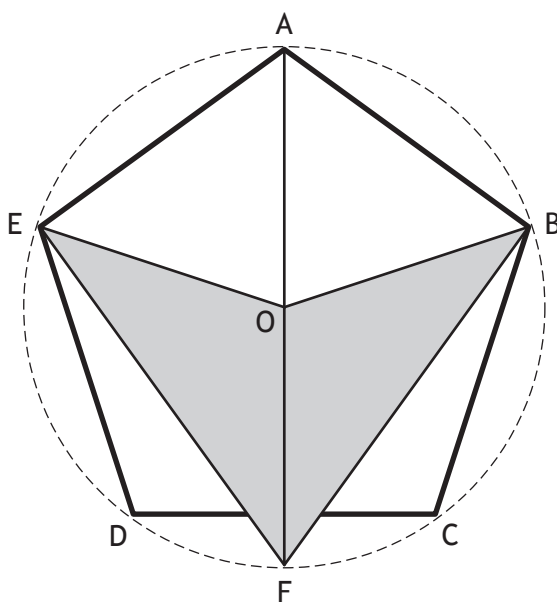

AF is a diameter of the circle.
 Calculate the size of angle OFB.

3



12. Express $\frac{\sqrt{2}}{\sqrt{40}}$ as a fraction with a rational denominator.
Give your answer in its simplest form.

3

13. Part of the graph of $y = 3\cos(x + 45)^\circ$ is shown in the diagram.

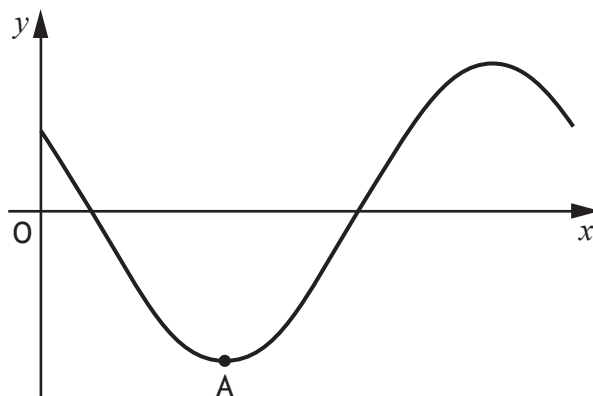

The graph has a minimum turning point at A.
State the coordinates of A.

2





MARKS

DO NOT
WRITE IN
THIS
MARGIN

14. Solve the equation $\frac{x}{2} - 1 = \frac{3-x}{5}$.

3

| |
|--|
| |
|--|



* X 8 4 7 7 5 0 1 1 3 *

15. A ball is kicked from a clifftop.

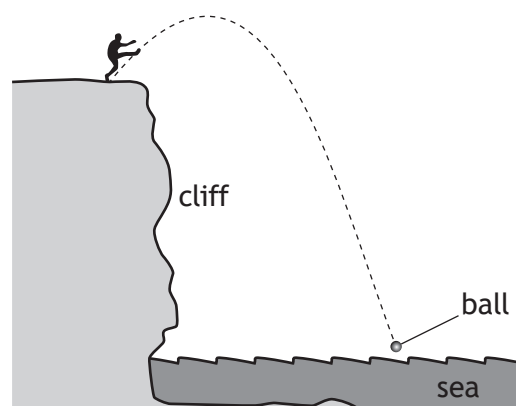

The height, h metres, of the ball relative to the clifftop after t seconds is given by $h = 12t - 5t^2$.

- (a) Calculate the height of the ball above the clifftop after 2 seconds.

1



15. (continued)

The graph below represents the height, h metres, of the ball relative to the clifftop after t seconds.

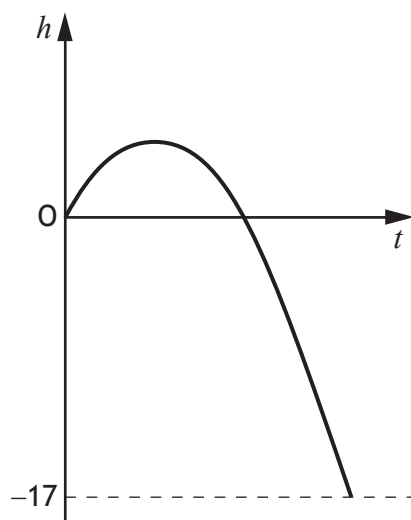

The sea is 17 metres below the clifftop.

(b) After how many seconds will the ball hit the sea?

4

[END OF QUESTION PAPER]



MARKS

DO NOT
WRITE IN
THIS
MARGIN

ADDITIONAL SPACE FOR ANSWERS



* X 8 4 7 7 5 0 1 1 6 *

MARKS

DO NOT
WRITE IN
THIS
MARGIN

ADDITIONAL SPACE FOR ANSWERS



* X 8 4 7 7 5 0 1 1 7 *

[BLANK PAGE]

DO NOT WRITE ON THIS PAGE



* X 8 4 7 7 5 0 1 1 8 *

[BLANK PAGE]

DO NOT WRITE ON THIS PAGE



[BLANK PAGE]

DO NOT WRITE ON THIS PAGE



* X 8 4 7 7 5 0 1 2 0 *

FOR OFFICIAL USE



National
Qualifications
2019

Mark

X847/75/02

**Mathematics
Paper 2**

FRIDAY, 3 MAY

10:45 AM – 12:35 PM



* X 8 4 7 7 5 0 2 *

Fill in these boxes and read what is printed below.

Full name of centre

Town

Forename(s)

Surname

Number of seat

Date of birth

Day

Month

Year

Scottish candidate number

Total marks — 60

Attempt ALL questions.

You may use a calculator.

To earn full marks you must show your working in your answers.

State the units for your answer where appropriate.

Write your answers clearly in the spaces provided in this booklet. Additional space for answers is provided at the end of this booklet. If you use this space you must clearly identify the question number you are attempting.

Use **blue** or **black** ink.

Before leaving the examination room you must give this booklet to the Invigilator; if you do not, you may lose all the marks for this paper.



* X 8 4 7 7 5 0 2 0 1 *

FORMULAE LIST

The roots of $ax^2 + bx + c = 0$ are $x = \frac{-b \pm \sqrt{(b^2 - 4ac)}}{2a}$

Sine rule $\frac{a}{\sin A} = \frac{b}{\sin B} = \frac{c}{\sin C}$

Cosine rule $a^2 = b^2 + c^2 - 2bc \cos A$ or $\cos A = \frac{b^2 + c^2 - a^2}{2bc}$

Area of a triangle $A = \frac{1}{2}ab \sin C$

Volume of a sphere $V = \frac{4}{3}\pi r^3$

Volume of a cone $V = \frac{1}{3}\pi r^2 h$

Volume of a pyramid $V = \frac{1}{3}Ah$

Standard deviation $s = \sqrt{\frac{\Sigma(x - \bar{x})^2}{n - 1}}$

or $s = \sqrt{\frac{\Sigma x^2 - \frac{(\Sigma x)^2}{n}}{n - 1}}$, where n is the sample size.



* X 8 4 7 7 5 0 2 0 2 *

MARKS

DO NOT
WRITE IN
THIS
MARGIN

Total marks — 60
Attempt ALL questions

1. A charity distributed 80 000 emergency packages during 2018.

This number is expected to increase by 15% each year.

Calculate how many emergency packages the charity expects to distribute in 2021.

3

2. Find $|\mathbf{p}|$, the magnitude of vector $\mathbf{p} = \begin{pmatrix} 6 \\ 27 \\ -18 \end{pmatrix}$.

2



* X 8 4 7 7 5 0 2 0 3 *

3. The diagram shows triangle PQR.

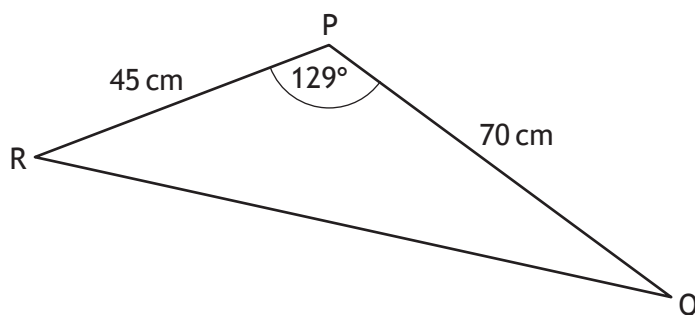

- PR = 45 centimetres
- PQ = 70 centimetres
- Angle QPR = 129°

Calculate the area of triangle PQR.

2

4. A sesame seed weighs 3.6×10^{-6} kilograms.

The weight of a poppy seed is 8% of the weight of a sesame seed.

Calculate the weight of a poppy seed in kilograms.

Give your answer in scientific notation.

2



5. The diagram shows a cone with diameter 6 units and height 8 units.

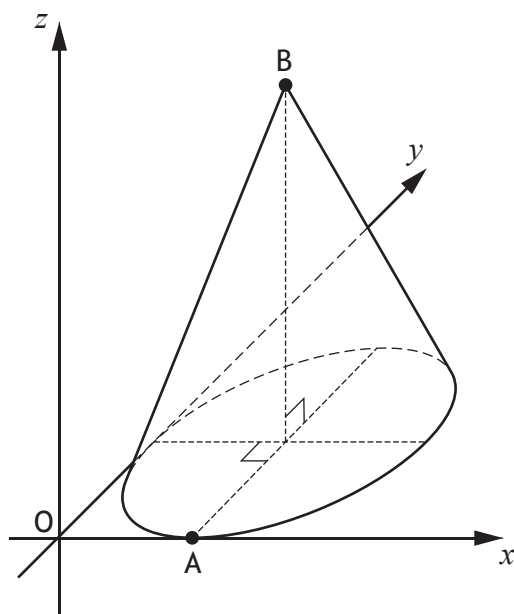

- The x -axis and the y -axis are tangents to the base
- A is the point of contact between the base and the x -axis
- B is directly above the centre of the base

Write down the coordinates of A and B.

2



MARKS

DO NOT
WRITE IN
THIS
MARGIN

6. Solve the equation $3x^2 + 9x - 2 = 0$.
Give your answers correct to 1 decimal place.

3



* X 8 4 7 7 5 0 2 0 6 *

MARKS

DO NOT
WRITE IN
THIS
MARGIN

7. Triangle XYZ is shown below.

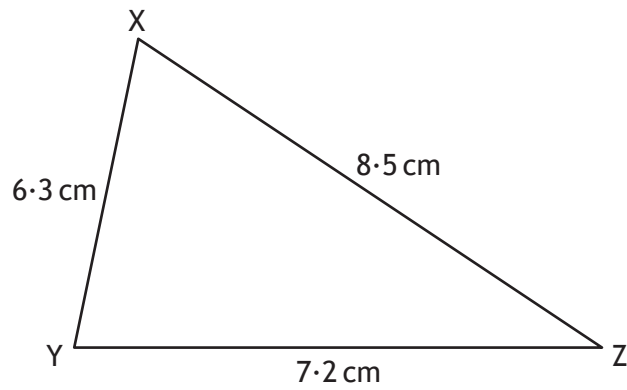

Calculate the size of the smallest angle in triangle XYZ.

3



MARKS

DO NOT
WRITE IN
THIS
MARGIN

8. A traffic bollard is in the shape of a cylinder with a hemisphere on top.

The bollard has

- diameter 24 centimetres
- height 70 centimetres.

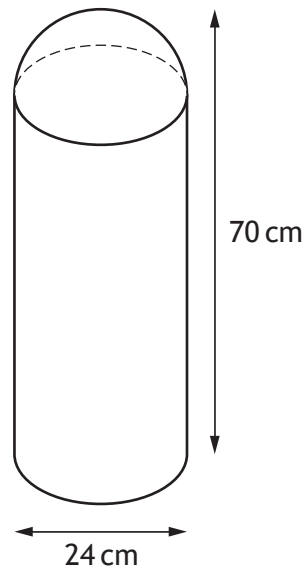

Calculate the volume of the bollard.

Give your answer correct to 3 significant figures.

5



* X 8 4 7 7 5 0 2 0 8 *

MARKS

DO NOT
WRITE IN
THIS
MARGIN

9. Georgie had her roof repaired.
She was charged an extra 2.5% for late payment.
She had to pay a total of £977.85.
Calculate how much she would have saved if she had paid on time.

3

10. Express $x^2 + 10x - 15$ in the form $(x + p)^2 + q$.

2



* X 8 4 7 7 5 0 2 0 9 *

11. The diagram shows the course for a jet-ski race.
 The course is indicated by markers A, B and C.
 The total length of the course is 1500 metres.

- B is 600 metres from A
- C is 650 metres from A
- C is due north of B

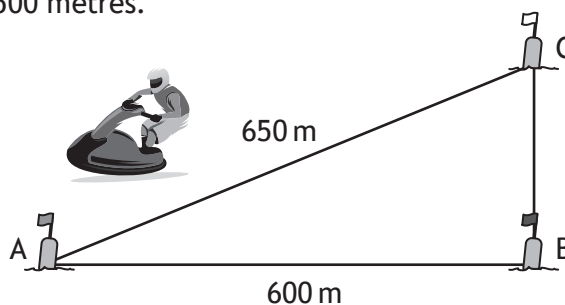

Determine whether B is due east of A.
 Justify your answer.

4

12. In the diagram

- ABC is a sector of a circle, centre C
- DEF is a sector of a circle, centre F.

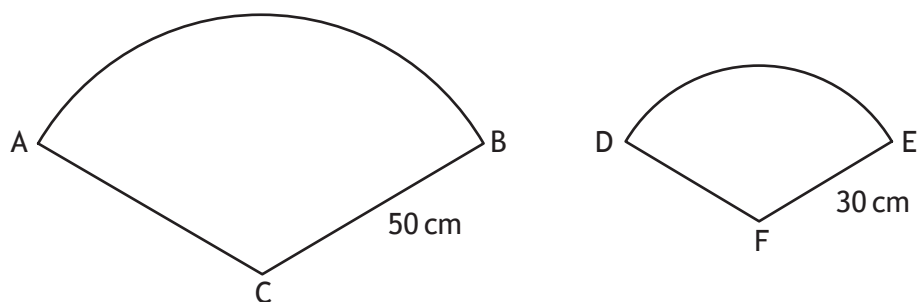

The sectors are mathematically similar.

The area of the larger sector, ABC, is 2750 square centimetres.

(a) Calculate the area of the smaller sector, DEF.

3

(b) Calculate the size of angle ACB.

3



MARKS

DO NOT
WRITE IN
THIS
MARGIN

13. Find an expression for the gradient of the line joining point A(6,9) to point B(4p,4p²).
Give your answer in its simplest form.

3

14. Solve the equation $5\cos x^\circ + 2 = 1$, $0 \leq x < 360$.

3



* X 8 4 7 7 5 0 2 1 2 *

MARKSDO NOT
WRITE IN
THIS
MARGIN

15. Express

$$\frac{4}{x-2} - \frac{3}{x+5}, \quad x \neq 2, x \neq -5$$

as a single fraction in its simplest form.

3

16. Simplify $\frac{a^4 \times 3a}{\sqrt{a}}$.

3



* X 8 4 7 7 5 0 2 1 3 *

MARKS

DO NOT
WRITE IN
THIS
MARGIN

17. Expand and simplify

$$(\sin x^\circ + \cos x^\circ)^2.$$

Show your working.

2



* X 8 4 7 7 5 0 2 1 4 *

18. The picture shows a cartoon snowman.



The diagram below represents the snowman.

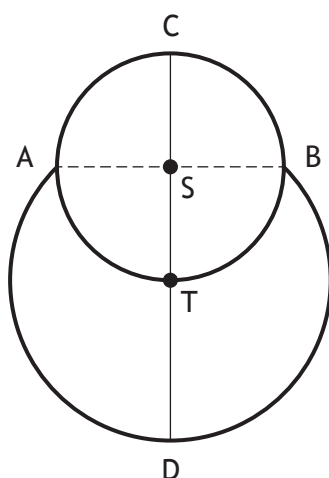

- The head is a small circle, centre S , with diameter 15 centimetres
- The body is part of a larger circle, centre T
- The point T lies on the circumference of the small circle
- The points A and B lie on the circumferences of both circles

Calculate CD , the height of the snowman.

4



19. Katy and Mona are looking up at a hot-air balloon.

In the diagram below, K, M and B represent the positions of Katy, Mona and the balloon respectively.

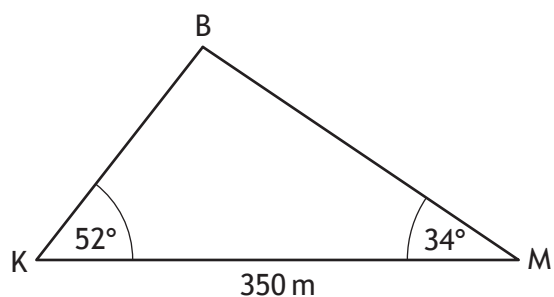

- The angle of elevation of the balloon from Katy is 52°
- The angle of elevation of the balloon from Mona is 34°
- Katy and Mona are 350 metres apart on level ground

Calculate the height of the hot-air balloon above the ground.

5

[END OF QUESTION PAPER]



MARKS

DO NOT
WRITE IN
THIS
MARGIN

ADDITIONAL SPACE FOR ANSWERS



* X 8 4 7 7 5 0 2 1 7 *

MARKS

DO NOT
WRITE IN
THIS
MARGIN

ADDITIONAL SPACE FOR ANSWERS



* X 8 4 7 7 5 0 2 1 8 *

[BLANK PAGE]

DO NOT WRITE ON THIS PAGE



* X 8 4 7 7 5 0 2 1 9 *

[BLANK PAGE]

DO NOT WRITE ON THIS PAGE

Acknowledgement of copyright

Question 11 Steinar/shutterstock.com



* X 8 4 7 7 5 0 2 2 0 *