

## Theorem of Pythagorus

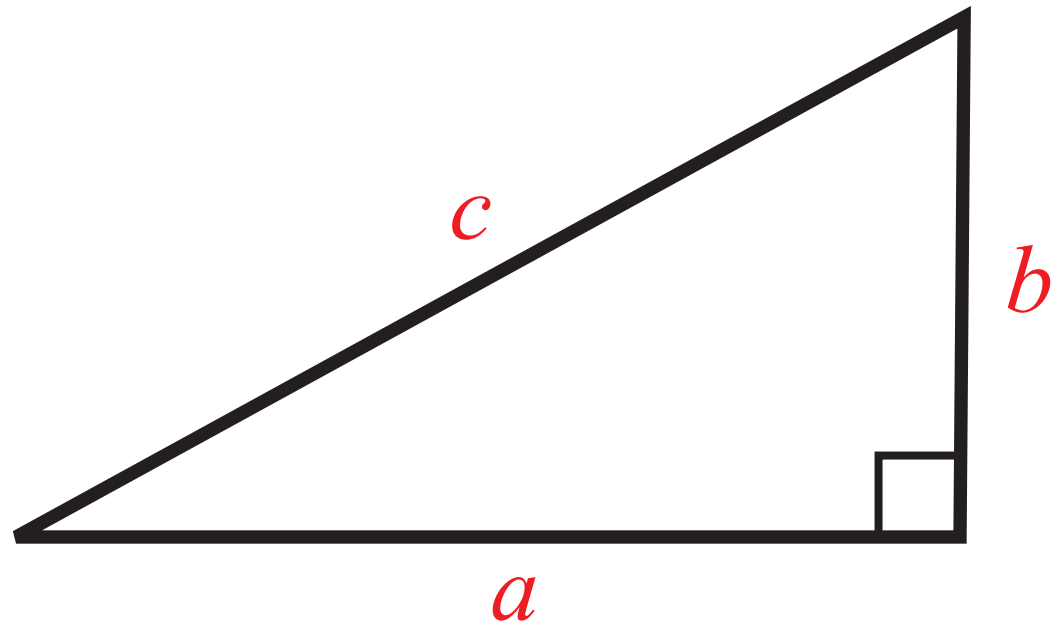

$$a^2 + b^2 = c^2$$

## Gradient

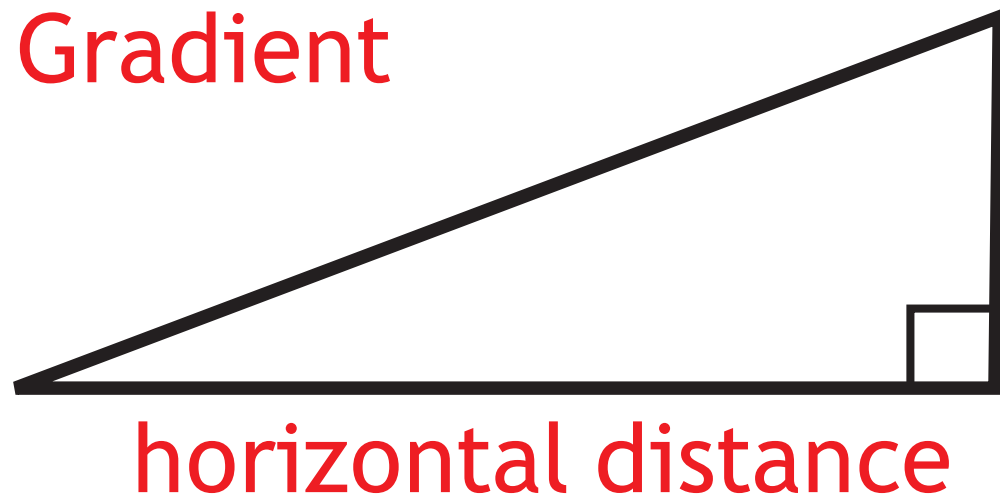

vertical  
height

$$\text{gradient} = \frac{\text{vertical height}}{\text{horizontal distance}}$$

Q4

Diagram 1

sandwich box

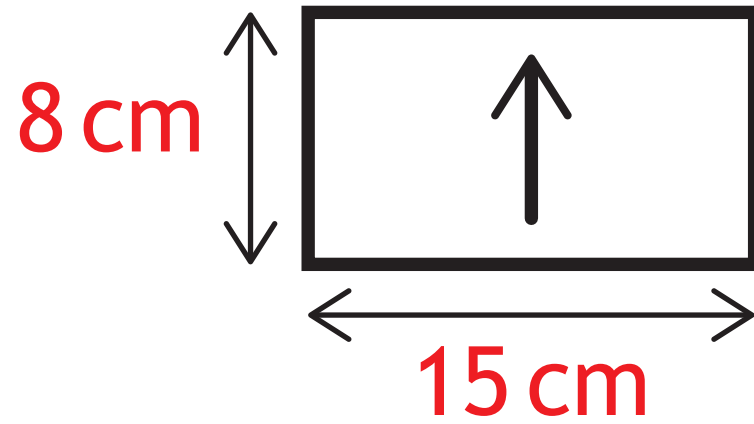
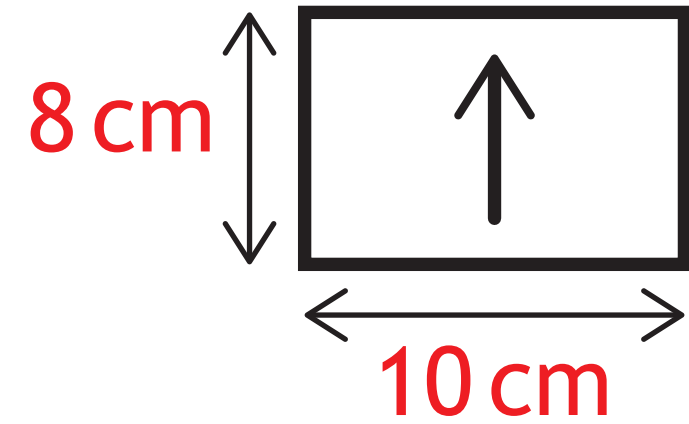
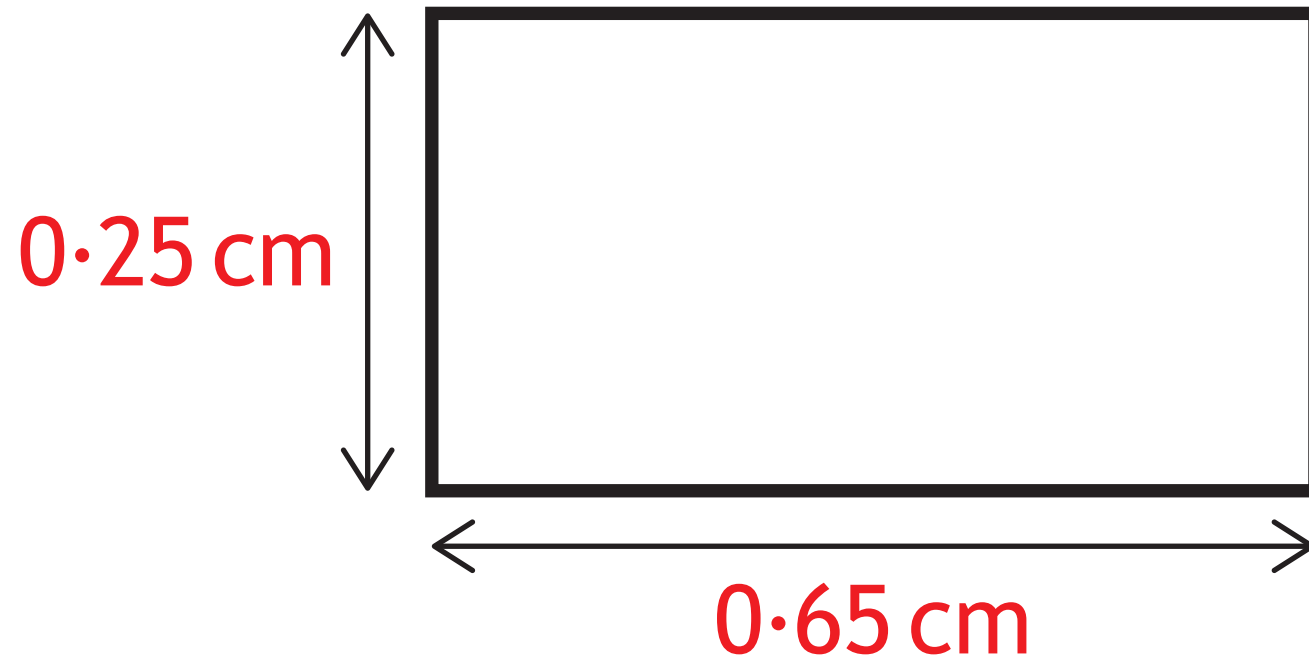

Diagram 2

sandwich box



crate



crate

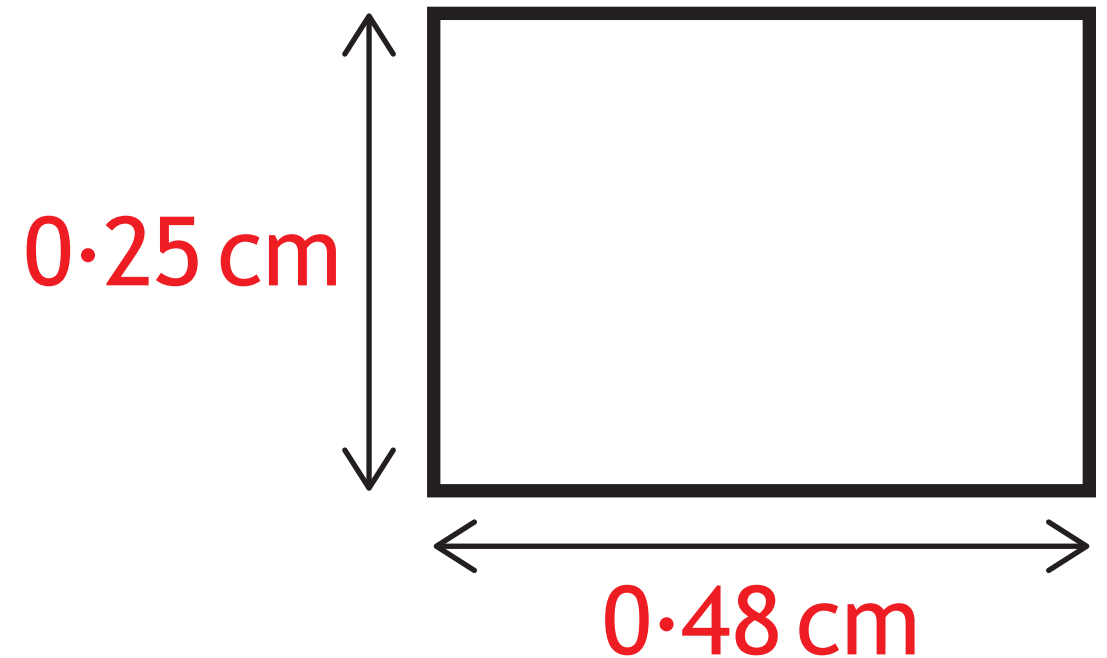

Q7b

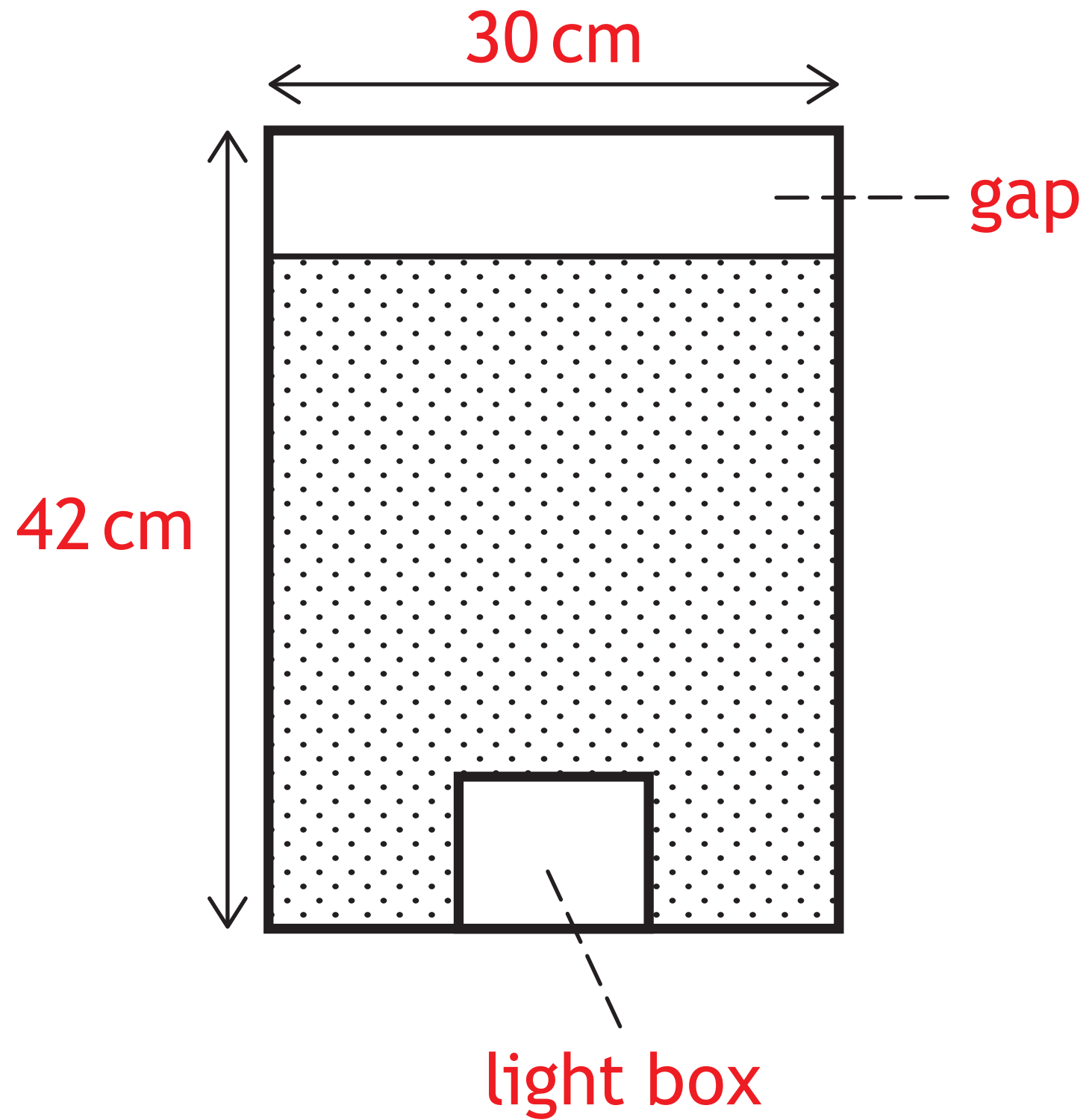

Q7c

